

Nov 38
RADIO'S GREATEST MAGAZINE

SPECIAL
VOCATIONAL
NUMBER

OVER 175 ILLUSTRATIONS

Radio-Craft

November
25 Cents

In United States
and Canada

HUGO GERNSBACK EDITOR

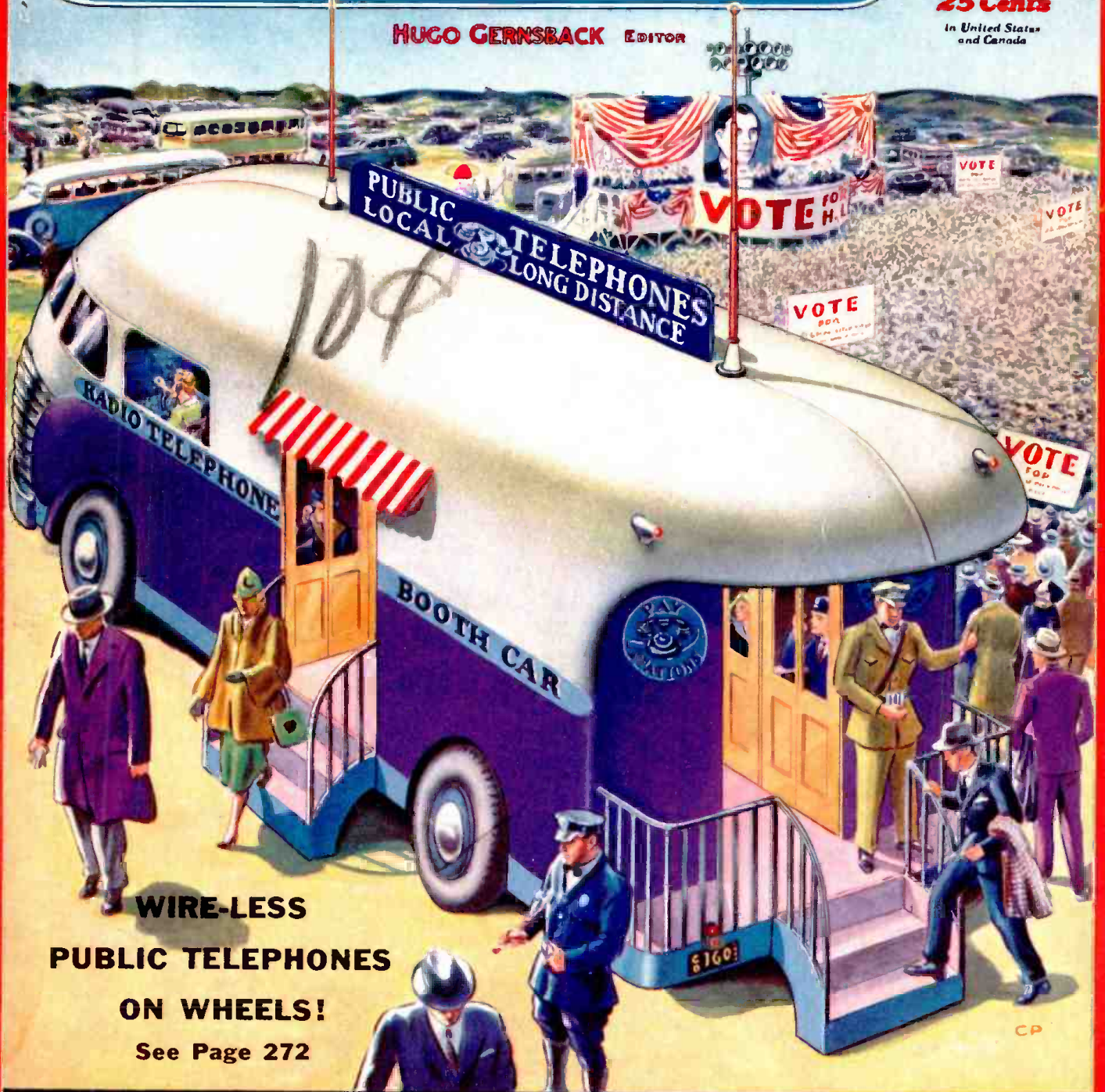

WIRE-LESS
PUBLIC TELEPHONES
ON WHEELS!

See Page 272

Home-Made Hearing-Aid • Emergency Radio Trailer • Beginners' 1-Tube Set
15 New Tubes • Radio's Vocational Appeal • Television on the Air Again

OVER 50,000 RADIO MEN READ RADIO-CRAFT MONTHLY

A COMPLETE SERVICE LABORATORY!



1

SUPREME LABRACK

The SUPREME LABRACK contains every function of a service laboratory, with the exception of 'scope and signal generator—and all in less than one square foot of bench space!

MODEL 594 SUBSTITUTION BOX by means of nine push-buttons allows rapid, accurate, temporary replacement from 1 ohm to 50M, 100M, 250M, 500M, 1 meg.; also capacitors 0.1, 0.5, and 8 mfd. Speeds up your replacement work 100%.

MODEL 594 TUBE TESTER with a new, modern tube testing circuit which utilizes the Model 592 set-tester's meter, and its GOOD—?—BAD scale. TOMORROW'S TUBE TESTER!

MODEL 593 ANALYZER designed to be used with any multimeter or set tester. Just connect your multimeter to the 593's two pin jacks, put the analyzer plug in the set's socket, the set's tube in the 593 and make voltage or resistance measurements!

MODEL 592 SET TESTER gives you a total of 47 ranges and functions with two D. C. volts sensitivity—both 1000 ohms per volt and 25,000 ohms per volt—in the same instrument! Completely self-contained. Push-button operated.

Cash price for the complete LABRACK, only \$91.25. Or can be bought for only \$8.36 down and \$8.36 for 11 months.

SUPREME OSCILLOSCOPE

Model 546 OSCILLOSCOPE is complete. Nothing else to buy or build. High gain amplifiers for vertical and horizontal plates. Built-in linear sweep circuit. Built-in "Snap-Lock" synchronizing control holds image on screen stationary. No wandering or wavering. Provisions for internal or external sweep and also for internal or external synchronization. High impedance, low capacitance amplifier circuits give flat frequency amplification to 30,000 cycles per second. Built-in sweep circuit is linear from 15 to 30,000 cycles, allowing observation of frequencies on the screen up to 300,000 cycles per second. Full 3 in. tube. Nine times as much effective screen area as a 1 in. tube.

Cash price, complete with six tubes, only \$59.95. Or \$5.50 down and \$5.50 for 11 months.

2



SIGNAL GENERATOR

Model 582 A SIGNAL GENERATOR gives you rapid, accurate PUSH-BUTTON tuning! That is possible because the 9 most frequently used frequencies (5 I.F. and 4 R.F.) are laboratory calibrated to an accuracy of 1/10 of 1%.

With your 546 scope connected to the proper output circuit, and the 582A connected to the first I.F. stage, all the necessary I.F. frequencies are instantly available by pushing the proper button. You always get the exact frequency you need. You make a complete visual alignment of the receiver. And by moving the output selector of the Model 582A from "Amplitude Modulation" to "Frequency Modulation" your scope shows a picture of the true I.F. Circuit conditions. You adjust for maximum amplification and the required selectivity characteristics.

To balance the R.F. Circuit connect the 582A to the receiver input. Check at 1400 KC, 1000 KC and 600 KC for balance with "Amplitude Modulation". Repeat with "Frequency Modulation" and the job is done.

Cash price, only \$66.95. Or \$6.14 down and 11 payments of \$6.14.

3



SUPREME

PUSH-BUTTON SET TESTER!

MODEL 592 is the sensational new Set Tester! with the push-button switching circuit which gives a total of 47 ranges with two D. C. volts sensitivities—both 1000 ohms per volt and 25,000 ohms per volt—in the same instrument! Resistance ranges to 50 meg. Panel area only slightly more than 1/3 square foot. Cash price, with case, only \$41.00. Or \$4.51 down and 9 payments of \$4.51!

SUPREME INSTRUMENTS CORP.
GREENWOOD, MISS., U. S. A.

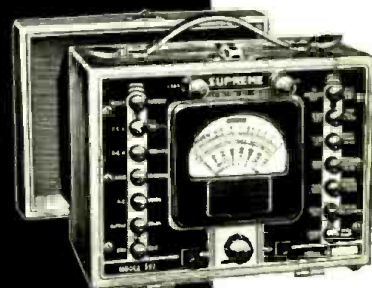

SUPREME INSTRUMENTS CORP.
Dept. RC-11, Greenwood, Mississippi

Please send me literature on:

..... Labrack Oscilloscope
..... Signal Generator Set Tester

Name

Address

City

State

Export Dept., Associated Exporters Co., 145 W. 45th St., New York City



J. E. SMITH
President
National Radio
Institute
Established 1914
The man who has
directed the
home study train-
ing of more men
for the Radio In-
dustry than any
other man in
America.

I WILL TRAIN YOU TO START A SPARE TIME OR FULL TIME RADIO SERVICE BUSINESS WITHOUT CAPITAL

**HERE ARE A FEW EXAMPLES
OF THE KIND OF MONEY
I TRAIN MY MEN TO MAKE**



**\$200 TO \$300 A MONTH
IN OWN BUSINESS**

"For the last 18 months I have been in business for myself, making between \$200 and \$300 a month. I have N.R.I. to thank for my start in this field."—ARTHUR J. FIEDLER, 221 W. Texas Ave., Goose Creek, Texas.

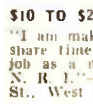

\$10 TO \$25 A WEEK IN SPARE TIME

"I am making from \$10 to \$25 a week in spare time while still holding my regular job as a machinist. I owe my success to N. R. I."—WM. F. RUPP, 203 W. Front St., West Conshohocken, Pa.



CHIEF OPERATOR BROADCASTING STATION

"When I completed 20 lessons, I obtained my Radio Broadcast Operator's License and immediately joined Station WMTB, where I am now Chief Operator."—HOLLIS F. HAYES, 85 Madison St., Lapeer, Mich.

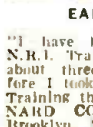

**EARNINGS TRIPLED BY
N.R.I. TRAINING**

"I have been doing nicely, thanks to N.R.I. Training. My present earnings are about three times what they were before I took the Course. I consider N.R.I. Training the finest in the world."—BENNETT COSTA, 952 Manhattan Ave., Brooklyn, N. Y.



OVER \$1,000 BEFORE GRADUATING

"Before completing half the N.R.I. Course I was servicing sets, and I made \$1,000 to \$1,200 before graduating. I am doing Radio service work for myself now."—ASHLEY G. ALDRIDGE, 1228 Shepherd St., Petersburg, Va.

Get My LESSON on Radio Servicing Tips FREE

I want to prove my Training gives practical, money-making information, that it is easy to understand—what you need to master Radio. My sample lesson text, "Radio Receiver Troubles—Their Cause and Remedy," covers a long list of Radio receiver troubles in A.C., D.C., battery, universal, auto, T. R. F., superheterodyne, all-wave, and other types of sets. And a cross reference system gives you the probable cause and a quick way to locate and remedy these set troubles. A special section is devoted to receiver check-up, alignment, balancing, neutralizing, testing. You can get this lesson Free by mailing the coupon.



**The Tested WAY
to BETTER PAY**

The world-wide use of Radio has made many opportunities for you to have a spare time or full time Radio service business of your own. Four out of every five homes in the United States have Radio sets which regularly need repairs, new tubes, etc. Servicemen can earn good commissions too, selling new sets to owners of old models. Even if you have no knowledge of Radio or electricity, I will train you at home in your spare time to sell, install, fix, all types of Radio sets; to start your own Radio business and build it up on money you make in your spare time while learning. Mail coupon for my 64-page book. It's Free—it shows what I have done for others—what I am ready to do for you.

**Many Make \$5, \$10, \$15 a Week Extra
in Spare Time While Learning**

The day you enroll I start sending Extra Money Job Sheets; show you how to do Radio repair jobs. Throughout your training I send plans and directions that made good spare time money—\$200 to \$500—for hundreds, while learning. I send you special Radio equipment to conduct experiments and build circuits. This 50-50 method of training makes learning at home interesting, fascinating, practical.

**Why Many Radio Experts Make
\$30, \$50, \$75 a Week**

Radio is young—yet it's one of our large industries. More than 28,000,000 homes have one or more Radios. There are more Radios than telephones. Every year millions of Radios get out of date and are replaced. Millions more need new tubes, repairs. Over \$50,000,000 are spent every year for Radio repairs alone. Over 5,000,000 auto Radios are in use; more are being sold every day, offering more profit-making opportunities for Radio experts. And RADIO IS STILL YOUNG, GROWING, expanding into new fields. The few hundred \$30, \$50, \$75 a week jobs of 20 years ago have grown to thousands. Yes, Radio offers opportunities—now and for the future!

**Get Ready Now for Your Own Radio Business
and for Jobs Like These**

Radio broadcasting stations employ engineers, operators, station managers and pay up to \$5,000 a year. Fixing Radio sets in spare time pays many \$200 to \$500 a year—full time jobs with Radio jobbers, manufacturers and dealers as much as \$30, \$50, \$75 a week. Many Radio Experts open full or part time Radio sales and repair businesses. Radio manufacturers and jobbers employ testers, inspectors, foremen, engineers, servicemen, and pay up to \$6,000 a year. Automobile,

police, aviation, commercial Radio, loud speaker systems are newer fields offering good opportunities now and for the future. Television promises to open many good jobs soon. Men I trained have good jobs in these branches of Radio. Read how they got their jobs. Mail coupon.

**I ALSO GIVE YOU
THIS PROFESSIONAL
SERVICING
INSTRUMENT**



Here is the instrument every Radio expert needs and wants—an All-Wave, All-Purpose, Set Servicing Instrument. It contains everything necessary to measure A.C. and D.C. voltages and current; to test tubes, resistance; adjust and align any set, old or new. It satisfies your needs for professional servicing after you graduate—can help you make extra money fixing sets while training.

**Save Money—Learn At Home
Money Back Agreement Protects You**

I am so sure I can train you to your satisfaction that I agree in writing to refund every penny you pay me if you are not satisfied with my Lessons and Instruction Service when you finish. A copy of this agreement comes with my Free Book.

Find Out What Radio Offers You

Act Today. Mail the coupon now for Sample Lesson and 64-page book. They're free to any fellow over 16 years old. They point out Radio's spare time and full time opportunities and those coming in Television; tell about my training in Radio and Television; show you letters from men I trained, telling what they are doing and earning. Find out what Radio offers YOU! MAIL COUPON in an envelope, or paste on a post-card—NOW!

**J. E. SMITH, President
National Radio Institute,
Dept. 8MX
Washington, D. C.**

**THIS
FREE BOOK
HAS HELPED
HUNDREDS OF
MEN MAKE
MORE
MONEY**



**GOOD FOR BOTH 64 PAGE BOOK FREE
SAMPLE LESSON FREE**

J. E. SMITH, President, National Radio Institute,
Dept. 8MX, Washington, D. C.

Without obligating me, send your Lesson "Radio Receiver Troubles—Their Cause and Remedy," and free book about spare time and full time Radio opportunities and how I can train for them at home in my spare time—about the N.R.I. Set Servicing Instrument. I am particularly interested in the branch of Radio checked below.

- Radio Service Business of My Own
- Spare Time Radio Repair Work
- Retail Sales of Radio Sets and Equipment
- Service Expert for Retail Stores
- Broadcasting Station Operator
- Aviation Radio Operator
- Loud Speaker Systems, Installations and Service
- Auto Radio Installation and Service
- Television Station Operator
- Service Expert with Radio Factory
- Commercial Radio Station Operator
- All-around Servicing Expert

(If you have not decided which branch you prefer—mail coupon now, for information to help you decide.)

NAME AGE

ADDRESS 14X1



HUGO GERNSBACK, Editor-in-Chief

R. D. WASHBURNE
Managing Editor

N. H. LESSEM
Associate Editor

ROBERT EICHBERG
Trade Digest Editor

THOS. D. PENTZ, Art Director

CONTENTS—Nov. 1938, Issue

Volume X

Number 5

Editorial: Radio Vocation Today.....	Hugo Gernsback	260
The Radio Month in Review.....		262
Cash-In on Your Radio Education.....		265-266
Build this Pocket-Size, 3-Tube Hearing-Aid	Howard G. McEntee	268
Television—Goes to High School.....		270
Television—Pops On & Off!.....		270
New 42-Passenger Airliner Boasts Super-Radio System		271
Wire-Less Public Telephones on Wheels!.....		272
Electronic Organ Helps Dit-Dah Boys!.....		272
Emergency Radio Trailer of the American Legion	Frederick P. Rogers	273
". . . By Electrical Transcription".....		274
Developments Increase Radio's Vocational Appeal.....		276
Operating Notes		278
Servicing Questions & Answers.....		279

Beginners' "Breadboard Special"—1-Tube High-Gain All-Wave Receiver.....	N. H. Lessem	280
15 New Tubes!.....	R. D. Washburne	282
Latest Sideline for Servicemen—Electric Fence Unit	M. N. Beitman	284
New Circuits in Modern Radio Receivers—No. 14	F. L. Sprayberry	285
RADIO SERVICE DATA SHEETS:		
No. 239—Stewart-Warner Models 91-51, 98-51, 910-51 Chassis		286
No. 240—Sears, Roebuck Silvertone Models 6003, 6004, 6024, 6034, 6124, 6134.....		287
The Latest Radio Equipment.....		288
Radio Trade Digest.....		289
"Signal-Test" System of Trouble-Shooting—Part II	John F. Rider	293
Book Review		318-320

EXPERIMENTERS' NUMBER

In the forthcoming, special Tube Number of Radio-Craft experimenters will find a wealth of articles of interest to specialists in Radio, Electronics and Public Address.

Servicemen will find in this issue many articles that describe new ways of doing the old jobs more quickly and profitably.

Of special interest will be a feature article illustrating and describing the new tubes scheduled for early release.

Published by Radcraft Publications, Inc. Publication office: 29 Worthington Street, Springfield, Mass. Editorial and Advertising Offices: 99 Hudson Street, New York City. Chicago Advertising Office: RADIO-CRAFT, 520 North Michigan Avenue, Chicago, Ill.

Foreign Agents:

London—Gorrings American News Agency, 9A Green St., Leicester Square, W. C. 2, England.
Paris—Messageries Dawson, 4 Rue Faubourg, Poissonniere, France.
Melbourne—McGill's Agency, 179 Elizabeth St., Australia.
Dunedin—James Johnston, Ltd., New Zealand.

RADIO-CRAFT is published monthly, on the first of the month preceding that of date; subscription price is \$2.50 per year in U. S. and Canada. (In foreign countries, \$3.00 a year to cover additional postage.) Entered at the post office at Springfield as second-class matter under the act of March 3, 1879.

Text and illustrations of this magazine are copyright and must not be reproduced without permission of the copyright owners.

Copyright 1938 Radcraft Publications, Inc.

TRAIN FOR RADIO IN 12 WEEKS

BY MY QUICK, EASY "LEARN BY DOING" METHOD



Prepare today to enter a real money-making field by my quick, easy way to learn Radio. Here in my school you are trained in 12 weeks for your start for a better job and a real future. You do actual work on a great outlay of Radio equipment. The remarkable "Learn-By-Doing" methods used in the great Coyne Shops train you in **Radio, Television** and sound equipment servicing. Not by books . . . Not by Correspondence . . . But all under the individual guidance of skilled instructors, and only on similar kind of work you will meet out on a real job. My methods make it **easy to learn**—First you are **told** how to do a thing—then you are **shown** how to do it—then you **do the work yourself**. WHERE ELSE CAN YOU FIND SO QUICK AND EASY A WAY TO GET PRACTICAL TRAINING IN THIS GIANT INDUSTRY?

I'LL FINANCE YOUR TRAINING

DON'T LET LACK OF MONEY keep you from sending in the Coupon TODAY. Learn how you can get training first and take more than a year to pay for it after graduation. Make your first payment 60 days after your regular 12 weeks' training period ends. Then take over a year to pay the balance of your tuition in easy monthly payments. Hundreds of ambitious fellows have used this method to get Coyne Training. **FILL IN THE COUPON AND MAIL IT TODAY.** It will bring you the details of this amazingly quick and easy way to get your start towards a good pay job.

Radio—Television—Sound Equipment

Your training at Coyne is in wonderful, modern daylight shops on the finest kind of RADIO, TELEVISION and SOUND EQUIPMENT. Television is sure to come as a commercial industry, whether this year or next. Talking Picture and Public Address Systems offer opportunities for the trained man. Everything possible has been done to make your stay at Coyne happy and healthful as well as profitable.

Electric Refrigeration Training Included at No Extra Cost

This combination Training (Radio and Refrigeration) can be of great value to you. Whether you go into business for yourself or get a job working for a Radio Sales and Service organization, the fact that you are trained in servicing Electric Refrigerators should be profitable to you. Many Radio Manufacturers also make Electric Refrigerators and men with this combination training are much more valuable to these employers. You can NOW get this training without extra cost.

No Advanced Education or Previous Experience Needed

If you can read and write simple English and are ambitious you can be trained the Coyne way—by actual experience on a wide variety of up-to-date Superheterodyne sets, oscillators, analyzers, and test instruments. You learn how to operate television receiving and transmitting equipment and how to install, test and service public address systems and sound picture equipment. Coyne training also helps prepare you to qualify for a government license examination as Amateur Broadcast or Telegraph Radio Operator and to know Code and Department of Commerce rules. Send coupon for all details.

H. C. LEWIS, President RADIO DIVISION Founded 1899
COYNE ELECTRICAL SCHOOL
 500 S. Paulina St., Dept. 88-8H Chicago, Ill.



H. C. Lewis

Part Time Work While Learning Employment Service after Graduation

If you need part time work to help pay living expenses while training, my Employment Department will help you get it. They will also give you Lifetime Employment Service after you graduate.

Mail Coupon Today I'll Send You All the Facts

Get the new "Coyne Opportunity Catalog," giving all facts about Coyne Training. Photographs of Shops showing students at work on modern radio equipment under the personal supervision of Coyne Expert Instructors. Also details of my Part Time Employment Offer, Pay After Graduation Plan and Graduate Employment Service. Yours without cost. Simply Mail the Coupon.



H. C. LEWIS, President,
 Radio Division, Coyne Electrical School,
 500 S. Paulina St., Dept. 88-8H, Chicago, Ill.

Send me your big FREE Book about Coyne Training and give me all details regarding your "Part Time Employment Offer" and "Pay After Graduation Plan" of easy, monthly payments.

NAME.....AGE.....

ADDRESS.....

CITY.....STATE.....

Please Say That You Saw It in RADIO-CRAFT

A New Policy!

FREE INSPECTION PLAN

You can buy any Gernsback Manual on Three Days' Approval

Perhaps you're new in Radio—or probably, in previous years you missed one of the Gernsback OFFICIAL RADIO SERVICE MANUALS. This is your opportunity to buy any edition you might need—get it in a way differently than ever before offered. Under a new policy—FREE INSPECTION PLAN—you can buy any Gernsback Manual on Three Days' Approval. There are thirteen Manuals and books from which to choose—every man in Radio should take advantage of this privilege.

Here Is How It's Done!

Order any GERNSBACK MANUAL illustrated and described on this page—the publishers will ship it to you immediately POSTPAID. When it reaches you, inspect its contents. If, after three days' inspection, you decide to keep the Manual, mail your remittance to the publishers. If the volume proves unsuitable, return it postpaid.

This plan is simple—there's no mystery or red tape—it gives you every opportunity to inspect the Manual of your selection. It costs you only a few cents return postage if you decide not to keep it.

Latest Volume 7 Manual Included

Volume 7 of the OFFICIAL RADIO SERVICE MANUAL—the edition which stamped the Radio industry this past year because it was published in a new way—in twelve monthly installments, is included under this new policy. This volume is now complete—twelve installments, totaling 1,800 pages, are bound in a hardcover binder and just packed with information you need today—and in the years to come. The coupon below gives you the privilege of inspecting this Manual also before you buy it.

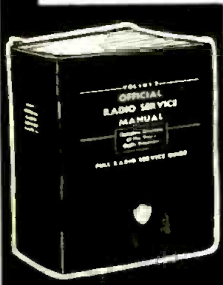

★ **VOLUME 7** ★
Newest of GERNSBACK MANUALS, contains schematic diagrams and service data on 1936-37-38 receivers. More up-to-date than any service guide published. 1,800 pages of material which radio men use every day. Wiring diagrams of over 1,200 different manufactured sets. Over 3,000 different illustrations. Bound in hard, loose-leaf covers—mechanism permits pages to be removed and replaced. Size—9 x 12 inches.
PRICE \$10.00



★ **1936 MANUAL** ★
Contains 1,200 pages (over 2,500 illustrations) packed with service data of 1935-36-37 sets. Diagrams of over 1,500 receivers. Shows speaker connections, power transformer connections. Alignment procedure, included with diagrams. Operating voltages for over 100 of sets are recorded. Assembly diagrams show relationship of separate units to each other. Size—9 x 12 inches; hard cover, looseleaf binder.
PRICE \$7.00



★ **1935 MANUAL** ★
An authentic radio service guide of over 1,000 pages with more than 3,000 illustrations—contains schematic diagrams of 1934-35 receivers. Features many old sets never previously described, early all-wave and short-wave sets, auto-radios, midket and clear-box receivers. Includes data on I.F. amplifiers, servicing instruments, tube information and FREE QUESTION AND ANSWER SERVICE. Size—9 x 12 inches; flexible, looseleaf covers.
PRICE \$7.00

★ **1935 AUTO-RADIO MANUAL** ★
OVER 240 PAGES
OVER 500 ILLUSTRATIONS
Looseleaf Binder—Flexible Covers
PRICE \$2.50



★ **1934 MANUAL** ★
Contains over 400 pages—over 2,000 illustrations. The schematic diagrams cover 1933-34 receivers. Features voltage readings, I.F. transformer values in superhets, valuable tube data and FREE QUESTION AND ANSWER SERVICE. A handy index makes it easy to find any information on service problems. Master index includes diagrams published in previous MANUALS. Size—9 x 12 inches; flexible, loose-leaf covers.
PRICE \$3.50



★ **1933 MANUAL** ★
This 700-page Manual, with over 2,000 illustrations, contains page after page of operating notes—schematics showing location of parts on chassis—values of I.F. coils, resistors and condensers. A complete section on construction of various types of test equipment, plus new-making ideas for radio men. Includes auto-radio installation and servicing. Size—9 x 12 inches; flexible, loose-leaf covers.
PRICE \$5.00



★ **1932 MANUAL** ★
This Manual contains a full radio service guide of 1931-32 receivers. With over 1,000 pages and over 2,000 illustrations, it features a step-by-step analysis in servicing a receiver—chart showing operation of vacuum tubes—schematic diagrams with color coding indicated—commercial short-wave receivers and adapters and servicing public address equipment. Size—9 x 12 inches; flexible, looseleaf covers.
PRICE \$5.00

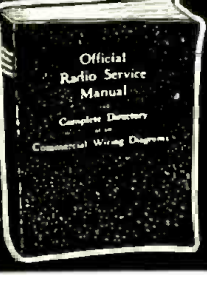

★ **1931 MANUAL** ★
The first of the famous GERNSBACK MANUALS contains all available wiring diagrams of nearly every receiver manufactured since 1927 and many prior to that year. This particular edition contains 650 pages (including supplements) with over 1,500 important diagrams. Most valuable to radio men is the RADIO SERVICE COURSE published in this edition. Size—9x12 inches; flexible, looseleaf covers.
PRICE \$4.50
including supplements.



OFFICIAL RADIO SERVICE HANDBOOK
Here's the sensational book on servicing. Covers over 500 topics. Contains a special section of 250 pages of Operating Notes. The book covers: Circuit Theory and Analysis; Modern Servicing and Test Equipment; Practical Trouble Shooting; Specialized Receiver and Installation Data; Modernization and Conversion Data, etc. Over 1,000 pages—over 1,000 illustrations; hard covers. Size 6 x 9 inches.
PRICE \$4.00

● This Policy Includes —

OFFICIAL REFRIGERATION SERVICE MANUAL (Volume 1) — \$5.00
OFFICIAL REFRIGERATION SERVICE MANUAL (Volume 2) — \$5.00
OFFICIAL AIR CONDITIONING SERVICE MANUAL — \$5.00

How To Get Any Manual You Need!

After you have definitely decided which Manual you want, fill in completely the coupon at the right. Clip it to your letterhead or paste on a penny post card and mail to the publishers. In a few days your Manual will reach you—Don't lose time—send coupon, TODAY, to

RADCRAFT PUBLICATIONS, Inc.
99 Hudson Street New York, N. Y.

RADCRAFT PUBLICATIONS, Inc. RC-1133
99 Hudson Street, New York, N. Y.

Please send me, POSTPAID.....for three
.....(Name of Manual or Book)

days' examination on approval. In three days I will remit to you the full cost of the Manual or book selected, or return the volume to you postpaid.

Name

Address

City State

Name of company or employer

(This offer is good only in continental United States.)

Please Say That You Saw It in RADIO-CRAFT



TRIPL
PUSH-BUTTON TESTING
 protected
AGAINST OBSOLESCENCE

• Push-button Testing must have wide flexibility to safely guard against obsolescence. Triplet has protected the service man with a unique circuit together with push-button individual selection to balance.

Many claim Dynamic Mutual Conductance . . . Triplet positively has it . . .

DYNAMIC MUTUAL CONDUCTANCE

Tube Tester and Volt-Ohm-Milliammeter

Model 1616

Many misleading names indicate a Dynamic Mutual Conductance Circuit . . . Triplet's is a true dynamic mutual conductance tester in every sense of the word.

Push-button control gives a new order of simplification. The buttons are clearly marked on chart at base. Just rotate the chart to the tube to be tested—then the button to push is indicated in line under each row of push buttons. What could be simpler? Release button for all switches.

A second revolutionary improvement is the arrangement of the measuring circuit of the dynamic mutual conductance test for amplifiers and power tubes. The tube tested not only shows GOOD or BAD but the percentage of mu to the 100% good condition is also indicated. In critical sets this permits the service dealer to pick his tubes with confidence . . . Diodes and rectifiers are tested for emission according to the latest approved engineering standards. Ballast tube continuity test and gas test also included.

Rotate chart to Volt-Ohm-Milliammeter settings—push button for D.C. scale: 0-10-50-250-500-1000 Volts at 1000 Ohms per Volt; 0-10-50-250 M.A.; .2 to 500 Ohms—300,000 Ohms—1 Megohms—3 Megohms; 0-10-50-250-500-1000 A.C. Volts at 400 Ohms per Volt; decibel chart furnished to 42 db's. (Ohmmeter is line powered.) Uses two interchangeable plug-in type rectifiers, simplifying replacement in case of unintentional damage.

Installed in attractive, all-metal case with lustrous finish. Removable cover. For portable or counter use . . . sloping panel. **\$73.34**

MODEL 1615

• Dynamic Mutual Conductance Tube Tester Only with Push-Button testing. Complete for counter or portable use. Dealer Price **\$63.34**

MODEL 1610

• Emission Type Tube Tester with Push-Button Testing approved R.M.A. circuit. Complete for counter or portable use. Dealer Price **\$39.00**

MODEL 1611

• Emission Type Tube Tester with Push-Button Testing and Volt-Ohm-Milliammeter. Similar to Model 1610 described above except Volt-Ohm-Milliammeter added. Ranges similar to those of Model 1616. Dealer Price **\$49.50**

BE SURE TO ENTER TRIPL
GET ENTRY BLANK FROM YOUR LOCAL JOBBER!

OTHER DYNAMIC MUTUAL CONDUCTANCE MODELS



TUBE TESTER AND VOLT-OHM-MILLIAMMETER
Model 1511

Has the same dynamic mutual conductance tube tester circuit and Volt-Ohm-Milliammeter ranges as Model 1616 but is in a standard 1500 series quartered oak case with selector switch controls. Illuminated instrument has a gold dial. Volt-Ohm-Milliammeter section is a separate panel with tip jacks and all controls attached.

DEALER PRICE **\$59.67**

MODEL 1510

Model 1510 is a Dynamic Mutual Conductance Tube Tester only. Attractive durable antique bronze etched panel with contrasting markings. Illuminated instrument has gold dial. In standard 1500 series quartered-oak case with selector switch controls. Same as 1511, less Volt-Ohm-Milliammeter.

DEALER PRICE **\$49.67**

All Volt-Ohm-Milliammeters shown equipped with exclusive Triplet plug-in rectifier that eliminates necessity for recalibration in case of accidental overloading.

NEW DE LUXE VOLT-OHM-MILLIAMMETER

Model 1601

25,000 OHMS PER VOLT

Incorporates also condenser tester and free point tester. Special Chart permits decibel readings against volts. D.C. Volts at 25,000 ohms per volt. A.C. Volts at 1000 ohms per volt. Undeniably one of the finest testers made today. Dealer Price . . . in Leatherette Case, \$49.33; in metal case



\$45.33

THE TRIPL

1611 Harmon Drive, Bluffton, Ohio

Please send me more information on

Model 1616; Model

Free Catalog. Details on Radio Service Puzzler Contest.

Name

Address

City State

Please Say That You Saw It in RADIO-CRAFT



“ TAKES THE RESISTANCE OUT OF RADIO ”

RADIO VOCATION TODAY

By the Editor — HUGO GERNSBACH

THE radio industry is no exception to that axiom that the outsider believes the “other” industry to be the most glamorous and the most profitable, while those within the industry are likely to maintain a pessimistic attitude and say that there is no future, or not much of a future in that industry.

Of course, neither side is correct so the fortunate fact remains that there is a happy medium between the two camps. I know of no single industry where the conditions are always excellent, nor where they are extremely bad. All industries have their ups and downs; most of them prosper in good times and suffer during depressions.

As in everything else, it is always the human element, in the final analysis, that is important. The Radio Industry is a tremendously large one, and in it there will be found many branches and sub-branches, which often are totally un-related to the other branches in the self-same industry. Thus the radio set industry may have an exceedingly poor year, whereas the broadcasting industry which sells time on the air, may not be affected at all during that same year. A moment's reflection will show why this must be so. It is exactly the same with most of the other radio branches and, because the industry is so very large, it is no longer possible to use generalities, because when it comes to radio vocations today, a new question must be asked; namely: *To which particular branch or sub-branch of the radio industry do you refer?*

I have attempted on this page to give a fair catalog of the radio industry in its major branches as it is constituted today. Lack of space, however, prevents listing

all of the sub-branches because the list would become many times as long as it is now.

So many young people write in to me continually, asking my advice regarding radio as a vocation. I have tried to answer this question by asking another question in turn.

To understand how complex the situation is I just wish to give a short résumé from a letter received during the past few days.

One young man from the middle West wishes to know what his chances are to gain a foot-hold in the broadcasting industry. Now that in itself is a fairly large order. The young man does not state in *what* branch of the radio broadcasting industry he is interested.

Is he interested in making a career in the broadcast engineering branch? Or does he wish to enter the broadcast field via the talent route (Musical, Acting, etc.)? Or is he interested in studio technique? Or does the advertising department of the broadcasting company offer more appeal to him? Or, again, is he interested in the recording branch of radio broadcasting? From this you can see how complex a *single* branch of the radio industry can be and how difficult it is to answer questions unless the whole background of the person—his education, natural preferences, etc.—are taken into consideration.

Similar questions, of course, must be asked for practically every branch of radio and no general answer can ever be given to those seeking a “radio” career, in the all-embracing industry known under that fascinating word: RADIO. Yet, the industry offers more real oppor-

(Continued on page 312)

THE RADIO INDUSTRY

- (1) MANUFACTURING
 - a—Radio Sets
 - b—Radio Parts
 - c—Radio Tubes
 - d—P.A. Amplifiers
 - e—Testing Equipment
 - f—Transmitters
 - g—Communication Receivers
- (2) MERCHANDISING
 - a—Mail-Order and Supply Companies
 - b—Distributors
 - c—Jobbers
 - d—Retailers
- (3) RADIO SERVICING
- (4) RADIO PUBLISHING
- (5) RADIO BROADCASTING
 - a—Radio Engineering
 - b—Sound Effects Engineers
 - c—Transcriptions
 - d—Maintenance Engineers
 - e—Radio Talent
- (6) TELEVISION
 - a—Microwave Experiments
 - b—Cathode-Ray Research
- (7) FACSIMILE
- (8) RADIO COMMUNICATIONS
 - a—Wired Radio Telephony and Telegraphy
 - b—Radio Typewriter
 - c—Transatlantic Radio Telephony
 - d—Ship-to-Shore Radio Telephony
 - e—Airplane-to-Ground Radio Telephony

(Continued on page 312)



Model 230-A 5 to 8 Watts

\$10⁹⁵



Model 246-A 15 to 18 Watts

\$15⁹⁵



Model 271-272 Remote & Standard 30 to 40 Watts

\$28⁷⁵



Model 261-A 25 to 35 Watts

\$20⁷⁰



Model 253-A AC-DC 20 to 30 Watts

\$33⁹⁵



Model 283-A 40 to 50 Watts with Equalizer

\$39⁹⁵



Model 269-A 6V-DC—110V-AC 20 to 30 Watts

\$43⁵⁰



Model 277-A 6 Channel 30 to 40 Watts

\$44⁷⁵



Model 291-A 70 to 100 W.

\$53⁷⁰



Model 334-T 6V-DC—110V-AC 30 to 40 Watts

\$87⁹⁵



Model 311-P 15 to 18 Watts Portable

\$33²⁵



Model 320-P 25 to 35 Watts Portable

\$41⁵⁰



\$21⁵⁰

Inter-Office Systems



\$19⁹⁵



Model 336-P Studio Portable

\$108⁷⁵

**MORE POWER PER DOLLAR
GREATER DEPENDABILITY
FINER PERFORMANCE**

that's Lafayette

Lafayette presents for 1939 the most complete line of quality-built Public Address Equipment in the world. Lafayette is, in fact, the only line with a sound system for every P. A. requirement. Any way you look at it, Lafayette means more for the money! More watts per dollar, more quality, more constant dependability. Yes, and this year Lafayette brings you even more amazing performance! Select your sound equipment from the line that is complete—and be assured of prompt delivery.

YOUR P. A. DOLLAR GOES FARTHER WHEN YOU GO LAFAYETTE

Model 340-P 40 to 55 Watts Deluxe Portable

Professional Deluxe Amplifying Equipment



Each Channel In Stock Prices On Request



\$74⁵⁰

NEW PA CATALOG

You asked for it and we are glad to give it to you. Our new big book showing the complete Lafayette line at list prices. Use it to show to your customers. It will help you sell them. Complete listings of all parts needed to complete any installation no matter how small or large. Write for your FREE copy today. It is waiting here for you. Don't miss a single sale. Write right now!

WHOLESALE RADIO SERVICE CO., INC.
100 SIXTH AVENUE, NEW YORK, N. Y.

Rush FREE List Price P.A. Catalog No. 74-3L8

Name _____
Address _____
City _____ State _____

PASTE COUPON ON PENNY POSTCARD

RUSH COUPON

WHOLESALE RADIO SERVICE CO. INC.
NEW YORK, N. Y. • CHICAGO, ILL. • ATLANTA, GA.
100 SIXTH AVENUE • 901 W. JACKSON BLVD. • 265 PEACHTREE STREET
BOSTON, MASS. • BRONX, N. Y. • NEWARK, N. J. • JAMAICA, L. I.

Please Say That You Saw It in RADIO-CRAFT



(Photo—Andre Lion)

JUNGLE PLATTERS

LAST month, *Radio Control* (Buenos Aires magazine), described the use of radio on the trek of the Schulz-Kamptenkel expedition to the jungles of Brazil, the Guianas, and Ecuador. In making this journey into the unexplored regions on the Northern frontier of Brazil, the most modern equipment at the command of science was used; the airplane, for instance, radio apparatus, and, of exceptional interest, a sound recording and playback set-up. The latter device is shown in use in the photo at left. For the natives to be able to hear their own voices, and those of their friends, was a surpassing bit of white man's magic. A storage battery supplied power for the equipment.

Phonograph discs (platters) make it possible to conveniently capture native sound effects which later can be dubbed to produce a sound film from a "silent."

PHONOTACTOR

A PROFESSOR of psychology, the National Broadcasting Company, a basso on the Carnation Contented commercial, and a 16-year N.B.C. songstress, together with a "teletactor", have ganged up last month to help Virginia Driess, deaf musical director, learn how to sing "The Star Spangled Banner." *Radio-Craft* is indebted to Prof. Robert H. Gault for the following description of his "teletactor."

It consists of a microphone, an amplifier designed to have a rising characteristic on voice frequencies, and an electromagnetic vibrating unit. A projection from this unit is tipped with cork; upon this the deaf person lightly rests his fingers. By watching the lips of a person, and feeling his words, the deaf person is able to increase the accuracy and completeness of interpretation of speech 15 to 25% over what he could do only by lip-reading.

THE RADIO MONTH TELEVISION

WHEN National Union's genial Marshall P. Wilder returned last month from his trip to Europe, he was all agog over the complete television receiver illustrated below. And well he might be—and so might we all. Get this. Complete set, including all-wave receiver and 11-inch cathode-ray tube, \$225!; cabinet measures only about 2 ft. long by 1 ft. high and deep! Image size is about 10 x 9 inches. It is probably the most compact television receiver, for a cathode-ray tube of such large size, ever put on the market.

This set by Fernseh, A. G., created a sensation at the Berlin Radio Show. The amazingly short cathode-ray tube length of about a foot was made possible by the

use of magnetic focusing—the trend today in European design.

English television receiver development has been toward smaller, direct viewing types. An end-on view of the tube results in increased brightness and wider angle of vision.

In order to properly merchandise television receivers it is felt that they *must* be of the dual television and all-wave type. Temporarily, however, they will be mostly single, with the sound being an auxiliary or supplementary arrangement, such as using an ultra-shortwave converter as described in August (1938) *Radio-Craft*.

Regular scheduled programs are
(Continued on page 296)

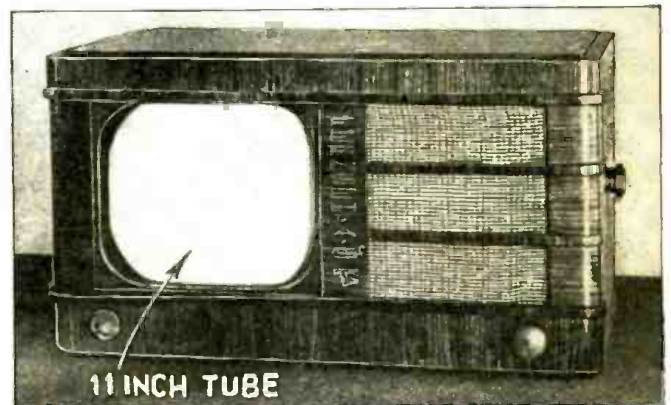

Here's your complete television receiver for \$225! Including all-wave reception and 11-inch cathode-ray tube. This is Fernseh A. G.'s handiwork. Magnetic deflection (coils outside the tube) instead of the more usual electrostatic deflection (deflector plates inside the tube) makes it possible to hold the tube length to about 12 ins.!

← Dr. Robert H. Gault, professor of psychology at Northwestern University, tells *Radio-Craft* readers that the "teletactor" shown at left is used to help the totally deaf to increase by as much as 25% their speed in learning lip-reading. Dr. Gault is holding the device, with its cork finger-tip rest.

RADIOIZED RIVET

RADIO waves were put to a new and novel use, last month, when, as the erection of steel on the Radio Corporation of America's exhibit building at the New York World's Fair 1939 was completed, the last rivet to be put into place was heated white-hot by radio.

The oscillator unit of a regular radio transmitter was set up on the framework of the exhibit building, and the output of the unit fed to a coil inside which the rivet was placed. In little more than a minute, the 1 kw. output of the oscillator (operating on about 5 megacycles) had raised the rivet to white-heat, and ready for the riveter shown at extreme right in photo. The other participants in the event were, left to right, Joseph D'Agostino (RCA), H. C. Bonfig (RCA), Robert Shannon (RCA) and John de J. Almonte, (N.B.C.).

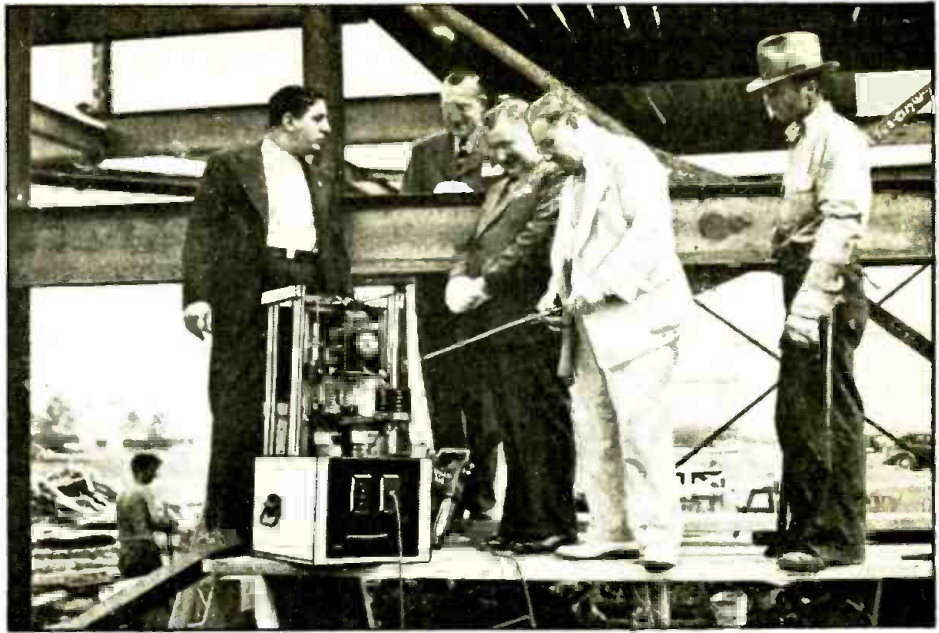

IN REVIEW

"PINKIE"-SIZE TUBES!

A GREAT future is predicted for the "pinkie"-finger size tubes announced last month by Hytron Laboratories. Shown here full-size, they are tinier than any that have so far come to the attention of *Radio-Craft*.

Only 2 tubes are shown here; the remaining tube looks almost identical. Line at present comprises a triode, input pentode and output pentode. Current drain is only 0.07-ampere (70 milliamperes), with a terminal potential of only 1.4 volts (which makes it convenient to operate these tubes on a single drycell).

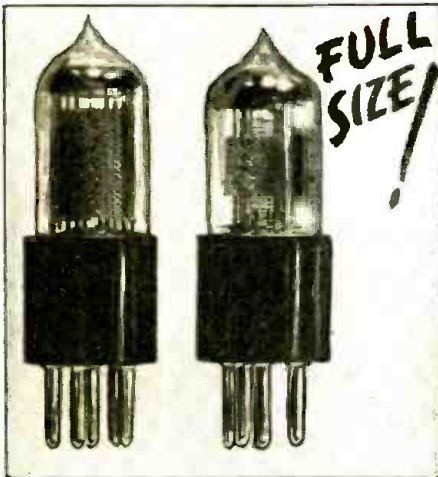

↑ The bulb of these lilliputian tubes is only 9/16-in. in diameter! Hytron proxy Coffin sees an immediate market for these tubes in hearing-aids for 5,000,000 whose hearing is impaired. Military, police, scout, and many other uses for these tubes are seen.

→ At right is illustrated the latest application of the "electric eye," which already has to its credit hundreds of applications that are becoming increasingly indispensable. It is here being used, with a relay and counter, to check-up on voting ballots.

ELECTRONICS

THE "Electric Eye" was used last month to prevent falsifying the ballot of the Annual American Bowling Congress, held in Chicago.

Voting to determine where the next Congress would be held, veteran bowler Harry Steers at right (and a G.E. employee) would have been hard put to it to register other than an accurate vote. When the voting card breaks the light-beam inside the ballot box a relay circuit is operated and the vote (card) is automatically tallied on a form of adding machine. To increase the vote it would be necessary to slip the cards in one after the other; but eagle-eyed E. H. Baumgartner, secretary of the Congress, is right on the job to see that doesn't happen. And if 2 cards are slipped through together, the automatic adding device will tally it as only a single vote—since the lightbeam will

be broken only once—and so our robot vote counter becomes orchid-eligible (poddon, Walter).

Betcha something like this would nearly eliminate recounts at the polls!

North China, according to an A.P. report last month from Sian, Shensi Province, is believed to be operating under the direction of Generalissimo Chiang Kai-Shek as the world's first "Government by radio."

Report is that more than 60 military radio stations are operating in nominally Japanese-controlled provinces, handling orders from the Central Chinese Government. Thus, an undercover army of Chinese guerillas who farm by day are directed in fighting by night.

Non-metallic tape transmission, which until now has been a European and Australian "monopoly," as 'twere, was
(Continued on page 318-320)

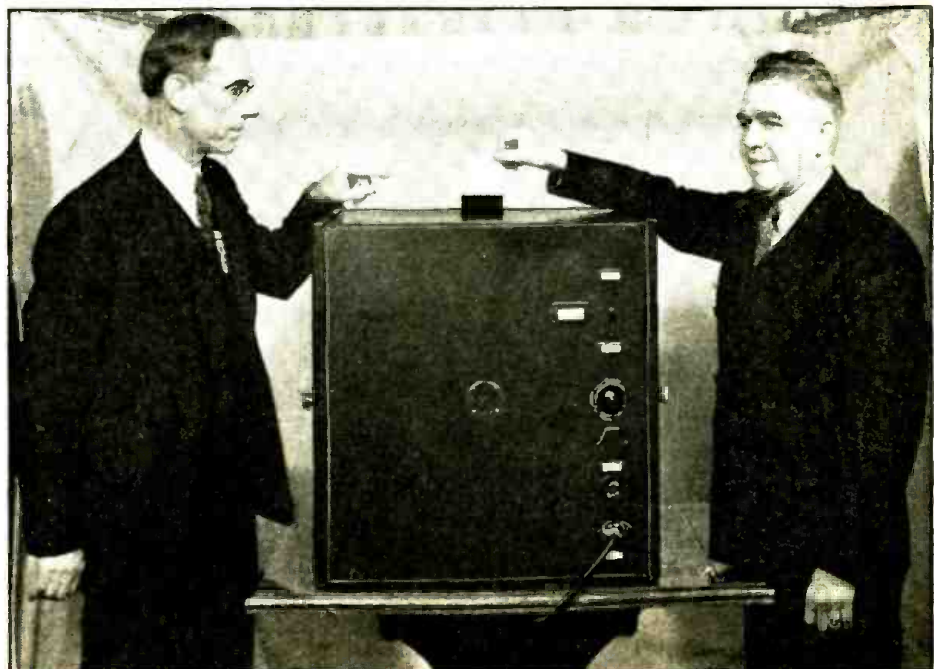

CASH-IN ON YOUR

At the request of RADIO-CRAFT a group of men, who over a period of many for success in their respective branches of the industry. These executives and on trends in the various respective fields of radio. The money-making possi-

RADIO SERVICING



JOHN F. RIDER

Publisher of Radio Service Books; President, Superior Instruments, Inc., New York, N. Y.

THERE are numerous ways of cashing-in on radio education, but one thing is certain: it is extremely difficult to accomplish anything in the technical branch of the radio field unless a radio education is the background. The man with the proper technical education is the individual with the best opportunity.

Our association with the radio industry has been in connection with the service branch. We have witnessed various changes in this field and the conclusions drawn during the past 5 years are being daily confirmed. The Serviceman with the technical background will be the one to survive the present weeding process.

We have seen the service branch pass through prosperous days and days of depression, yet in every part of the nation could be found Servicemen—men who had sufficient confidence to acquire a technical education—who made money during both periods.

A technical education does more than just fortify the Serviceman with the ability to do a job. . . . It also gives him the confidence he so badly needs to charge for the work he does. Therein lies the basis of success. . . . Every publication now being published in the interests of the radio industry contains material which proves that radio receivers have passed out of the simple class into the category of complicated apparatus. What with television in the ofing, there is no doubt about the fact that the men who work upon these instruments will require a technical background and further that the man with a radio education will have ample opportunity to cash-in on the money and time he spent acquiring the knowledge.

PUBLIC ADDRESS AND SOUND

JOHN ERWOOD

*The Webster Company
Chicago, Ill.*



THE Public Address and Sound field has often been referred-to as a "young" industry and this is true. It is a field today that can be compared to any of the matured industries that we now think of as mainstays of industry, as regards their position 25 or 30 years ago.

Success in this field, like any other, requires a lot of hard work and an abundance of imagination. Many people do not appreciate the headway that has been made in the standardization of equipment so that the sales problems encountered in selling Public Address equipment do not

materially differ from those of many other industries of widely varying nature.

Any product has to be sold and an analysis of the service rendered by Sound or Public Address equipment will reveal the fact that it has a definite place in the scheme of things today. It is not a passing fad but an industry that is growing in its application rapidly.

To be successful in the sale of Public Address equipment, one must ground himself in the fundamentals of selling and must be sold upon the fact that he has a definite service to render to society as a whole.

Perseverance and imagination will, if combined with the above and even ordinary talent, assure an excellent livelihood in a field of which it can be truly said that *the surface has hardly been scratched.*

ELECTRONICS

A. ADELMAN

*Photobell Corporation
New York, N. Y.*



ELECTRONIC equipment is being applied to industry as fast as it can be designed; yet the work is so vast and unplanned that many decades will be needed to bring the art to maturity. The radio-trained technician is the obvious heir to the job of filling-in the details of the structure of electronic machines whose foundation is now being laid. Many Servicemen, engineers, and other technicians appreciate the scope of this, and write to me for advice and information on how to enter the electronic field.

Electrons compete with the worker as well as with mechanical devices. In many industrial occupations it is now possible and practical to replace a pair of human eyes with *photocells*, to count, inspect, measure, indicate or control machinery, conveyors, products of all kinds. The "electric eye" is fast, accurate, consistent, non-fatiguing, and does not ask for wages. The trend is irresistibly toward replacement of labor, and designers will be needed for many years to study the adaptation of this tool to a multitude of industrial applications.

The "electric ear," or microphone; the "electric voice," or loudspeaker; the "electric nose," which detects dangerous odors; the "electric brain," which solves intricate mathematical problems; these are the beginnings of an Electronic Age, following hard on the heels of a purely Mechanical Age.

TEST EQUIPMENT

V. E. JENKINS

*Weston Electrical Instrument
Corp.
Newark, N. J.*



TEST equipment is the tool of the radio service industry. Education plus the proper tools represents cash value. A modern carpenter cannot build a
(Continued on page 307)

RADIO EDUCATION

years have contributed much to the progress of radio, outline the pre-requisites technicians have further enhanced their articles by including invaluable opinions abilities in the radio field are greater than ever before—and increasing every day.

RADIO RETAILING

DAVE FINN

Assistant Advertising Manager
RCA Manufacturing Co.



THE retail radio business can be a profitable field for the small as well as the large dealer if intelligent use is made of the great wealth of advertising and sales promotion aids that are available to both. Such sales-building helps are especially valuable to the service engineer who carries a limited line of radio sets in addition to his service business.

Since all advertising should be made to pay its own way, the small business man must of necessity begin his advertising campaign in a limited way. If he cannot afford to take newspaper space he can use classified ads, as many successful dealers are doing; or he can use, at little cost, sales promotion literature, window displays, streamers and other material prepared by the manufacturer.

The mails are a very valuable medium for potential business. Through direct-mail campaigns known prospects can be reached directly at reasonable cost. Word-of-mouth advertising, one of the most potent forces in building customer good will, is another sales aid that can be stimulated at little cost.

RCA Victor dealers and service engineers in all parts of the country have seen their business in retail radio and parts sales increase steadily under the influence of intelligent, carefully-planned promotion campaigns of the type described. The beginner in the retail field, whether he be an established service engineer or a newcomer, can soon build his own profitable business. He needs only a line of good merchandise and a few sales ideas.

TELEVISION

ALLEN B. DU MONT

President, Allen B. Du Mont
Laboratories, Inc.
Passaic, N. J.



IN the past several years great strides have been made in the laboratories toward bringing television to a point where the excellent detail of the pictures and the reliability of the apparatus now make it suitable to take its place in the home. However, the commercial progress of television in this country as far as actually putting programs on the air is concerned is considerably behind that of Europe. The immediate opportunities in America for men trained in television technique depend largely upon the cooperation of the government and commercial interests in the furthering of this new art.

It is inevitable that encouragement of the television industry would supply thousands of jobs for factory workers, engineers, Servicemen, studio technicians, station operators and artists. Just as new industries in the past—such as the Railroad, the Automobile, and then the Radio (broadcasting)—have led to eras of prosperity, so it will be with Television. Be foresighted—prepare now!

SHORT-WAVE EXPERIMENTING

JAMES MILLEN

General Manager,
National Company, Inc.



IF we were to go through the list of names of those who are dominating the radio business today, we would find that the vast majority of them were experimenters a few years ago. In fact, our own contact with such men has brought us to the conclusion that most of them entered radio as a hobby, with absolutely no idea that they would, some day, be making their livelihood from it.

And one of the best ways of looking into the future is to examine the present and the past. Therefore, it is our belief that the future will hold even greater opportunity for today's radio experimenter. We believe particularly, that the field of application of the ultra-high frequencies is almost entirely virgin.

Let us consider a single application of the "ultra-highs." A few years ago, 2-way police radio was almost unknown. Several thousand such installations have been made in that short time. To be specific: one such job was built by a former experimenter; sold, in his home town, for several thousand dollars, it gave him a nice profit and provided several weeks' work for 2 helpers. The maintenance of the installation is handled on a service contract basis, which brings in enough to pay his rent and it has thus enabled him to go into the manufacturing business, without any additional capital.

The opportunity for similar jobs is growing by leaps and bounds. When we think of the additional possibilities in the fields of local communication; the many applications to air and marine transportation, to say nothing of television, we believe that we are erring on the side of conservatism when we say that the ultra-high frequencies will provide 10,000 new and regular positions, within the next 3 years—just about the right time for the present experimenters.

RADIO MERCHANDISING

LEON L. ADELMAN

Sales Manager,
Cornell-Dubilier Electric Corp.



TO properly tell the "buying public" (whether technical or non-technical, depending upon the item) of what a manufacturer has to sell entails not only an extensive build-up of the merchandising personnel through study and hard work in all the related branches of the field in which the product is offered, but also a methodical development of policy which will be sufficiently flexible to meet the requirements of individual sales methods.

Space does not here permit an extensive analysis of the merit that lies in a wide knowledge of radio as a basis for
(Continued on page 309)

BUILD THIS POCKET-SIZE

Servicemen are the logical salespersons to act as the customer contact in merchandising man and used as a portable demonstration unit. Its features include crystal microphone

HOWARD G.

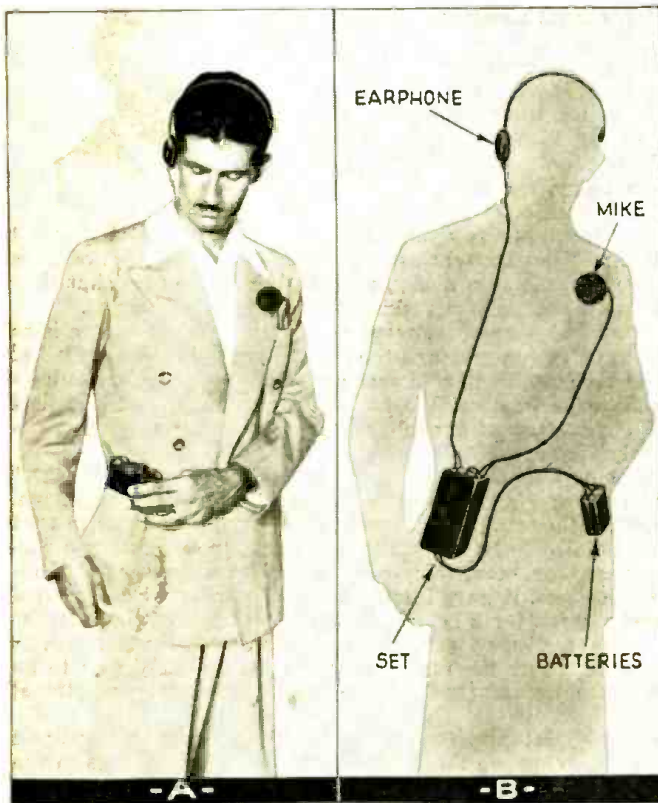

Fig. A. Left. The hearing-aid in use. The batteries are in the left-hand coat pocket. Right. Phantom view showing connecting wires.

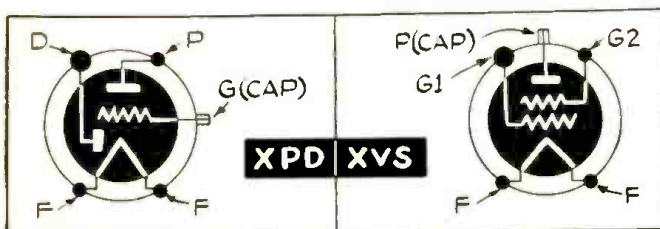

Fig. 3. Top socket connections of the "baby" tubes used.

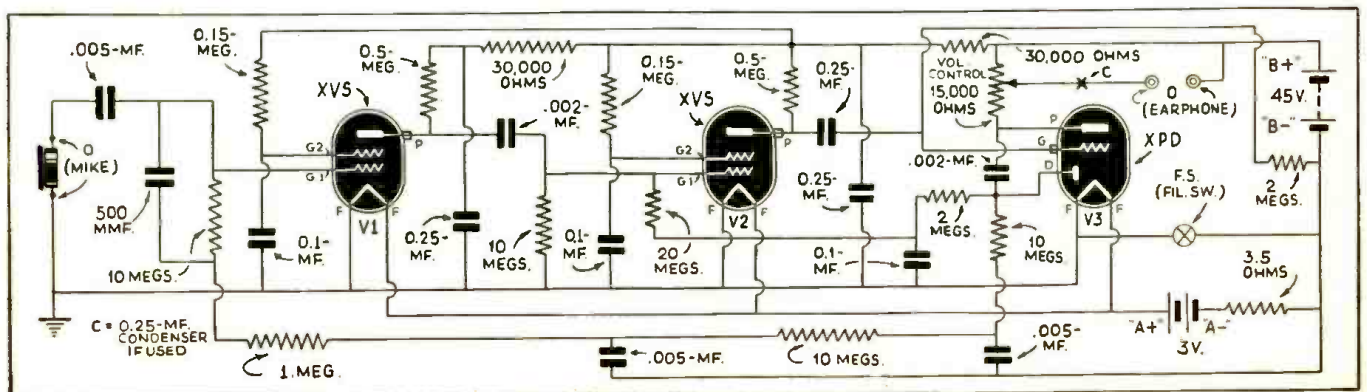

Fig. 1. Schematic diagram of the 3-tube, automatic audio volume control hearing-aid. The tubes, of English manufacture, are obtainable in this country.

THOSE who are hard-of-hearing will welcome the new idea presented here in the form of a custom-built pocket-size hearing-aid (see Figs. A, B and C). This idea is audio automatic volume control (or A.A.V.C.) and it is made feasible by the use of newly-developed, miniature radio tubes of English manufacture.

Two types are required for the purpose—a variable-mu screen-grid amplifier, designated XVS; and an output amplifier with a diode rectifier contained in the same bulb, this type called XPD. Both of these remarkable little tubes work on 2 volts at 75 ma. for the filament supply, so that long battery life is assured. The tubes are designed to work efficiently at 45 volts, at which potential they have amplification factors of 400 and 6.7, respectively.

The A.A.V.C. voltage (see schematic diagram of circuit, Fig. 1) is obtained in much the same manner as in an ordinary radio receiver, that is, by feeding some of the output voltage to a diode, where it is rectified and applied to the control-grids of the high-gain XVS tubes. On weak inputs these tubes operate at full gain, but as the input grows stronger, the A.A.V.C. voltage also increases, and is instrumental in reducing the gain, so that a constant level of output is assured. The manual volume control is placed in the output circuit so that it will not be affected by the A.A.V.C.

Since the power requirements are so modest, it is possible to operate the deaf-aid shown from the smallest available batteries, the filament current being around 0.2-A., while the total plate current is only about 2.5 ma.!

A crystal microphone is employed and should, of course, be of the highly-sensitive type designed for this service. These units are very compact and may be worn concealed under the wearing apparel.

During tests the amplifier was also tried out with a regular communications-type crystal microphone as well as with a crystal headphone used as a mike and both worked well. The amplifier even gave fine results when an ordinary high-impedance set of magnetic headphones was connected to the input terminals!

The output circuit is similarly universal, and any type of headphones of reasonably high impedance will give good results. Due to the fact that the output terminals are shunted across a variable resistor whose maximum value is 15,000 ohms, it is possible to use crystal earphone units without damage.

Some users may find it possible to use one of the tiny air-conduction or bone-conduction ear pieces with this

3-TUBE HEARING-AID

hearing-aids, and an easily-built unit such as here described can be built by the Service- and earphone, finger-size tubes, small-size batteries, and a "non-blasting" circuit.

McENTEE

apparatus. If so be sure to get the highest-impedance type that you can as they are also made in low-impedance types for other circuit applications. The tiny air-conduction units are made to fit directly in the ear where they are held by a small spring. No headband is necessary and only a small portion about $\frac{1}{2}$ x $\frac{3}{4}$ -inch is visible. A tiny cord is of course necessary for electrical connections.

The bone-conduction unit is also very tiny and is placed *behind* the ear directly against the skin. The electrical waves from the amplifier are translated into mechanical waves in the unit. These waves then pass through the bone to the inner-ear. In this manner the middle-ear through which sound waves ordinarily are transferred to the inner-ear by means of mechanical vibrations is completely bypassed. This is a great advantage since a good number of cases of deafness are caused by impairment of the mechanism of the middle-ear, although in most of these cases the inner-ear is in good condition.

CONSTRUCTION

Actual construction of the amplifier is quite simple. The main elements are the case, which carries the controls and input and output terminals, and a small aluminum chassis measuring $3\frac{1}{2}$ x 3 x $1\frac{3}{8}$ ins. deep which holds the tube sockets and all other circuit components.

The aluminum chassis is first marked out on 1/16-in. thick sheet after which the 3 holes for the tubes are cut (see Fig. 4). Also, four $\frac{1}{4}$ -in. diameter holes are cut in each end around the tube sockets to allow for passage of the connection wires. When these holes have been cut the chassis is bent to shape and the 3 sockets fastened in place. The com-
(Continued on page 300)

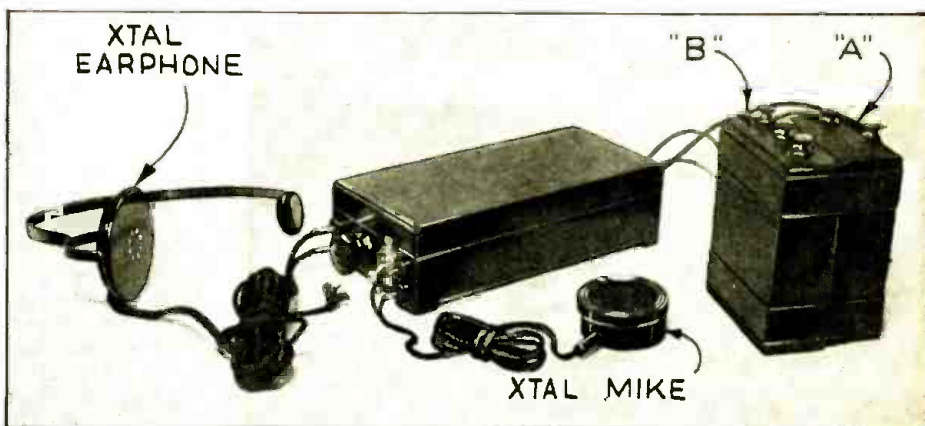

Fig. B. The complete hearing-aid system comprising 3-tube amplifier, crystal lapel microphone, crystal earphone and small batteries. The amplifier fits in one coat pocket, and the batteries in the other. See Fig. A on opposite page for suggested method of wearing the hearing-aid system. An "A.A.V.C." circuit prevents blasting on loud talking or when person talking approaches close.

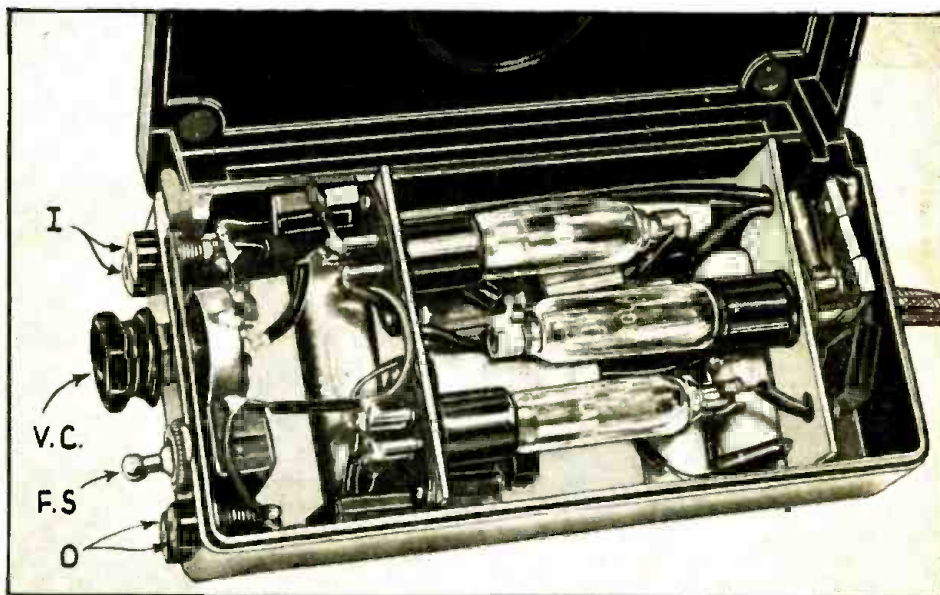

Fig. C. Inside view of the 3-tube amplifier. Note the aluminum chassis and the compact layout of all the components. Lettering is as follows: I, input; O, output; VC, volume control; FS, filament switch.

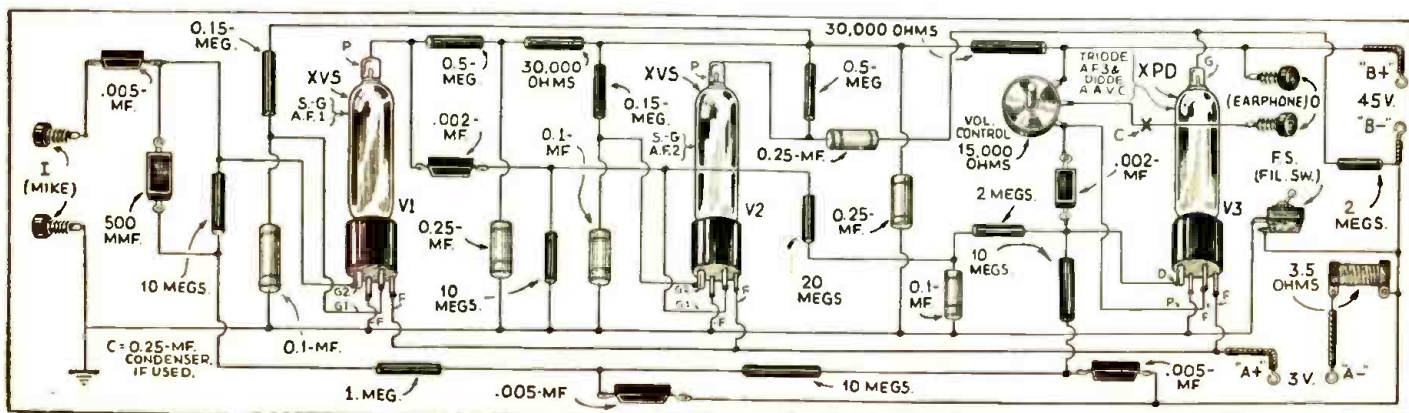
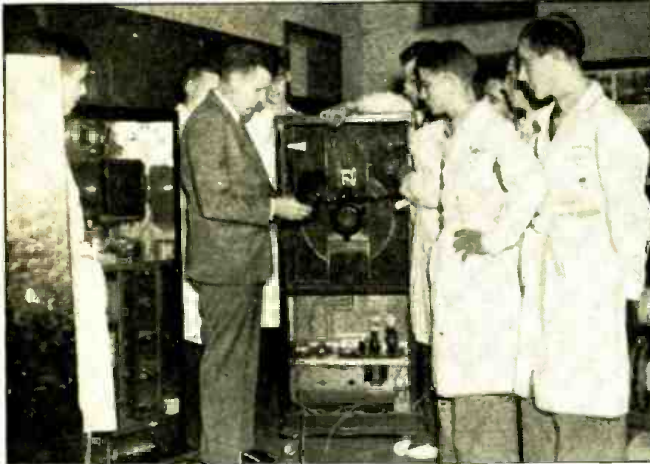

Fig. 2. Pictorial diagram of the 3-tube hearing-aid amplifier. Study the socket connections since they differ from those of American-made tubes.



TELEVISION — GOES TO HIGH SCHOOL

Dallas, Texas, pioneers a new path in education for children of high-school age.

STARTLING developments of the century's marvel invention during the past year have made it obvious that Television will become a flourishing industry within only a few years. Thousands of people throughout the nation will go to work as a result. And to Dallas, Texas, must go the credit for having the first city school system in the United States to realize the possibility of this great coming industry. A course in television is now being offered to young men in the Technical High School at Dallas—where youth is taking this television business seriously. In the top photo at the left, instructor A. M. Cowan is discussing the transmitter's photocells; the receiver is at his back. The scanning disc may be seen in the second or rear view.

It must be remembered that *the youth of today will be the scientists and electrical technicians of tomorrow*—the day of television. And the eyes of the nation are now turned to this high school experiment. Education must keep up with the pace of progress and industrial development if it is to succeed in assisting in solving some of the unemployment problems of the nation!

The course in the Dallas high school does not exactly tend to graduate finished students in television, preparing them to hold jobs operating machines. The development of the invention has not advanced enough for that. On the other hand, it seeks only to broaden interest for students for their future study in electrical laboratories which are now working consistently in developing the coming great industry.

(Continued on page 296)

TELEVISION — POPS ON & OFF AIR!

N.B.C./RCA gave a video appetizer last month.

AFTER being off the air for 2 months, during which numerous technical improvements—though none basic—were made in studio and transmitter equipment, the National Broadcasting Company's television station in New York City resumed broadcasting, August 23, on an experimental basis. Six 1-hour transmissions were to be made each week *over a period limited strictly to 1 month*. Experiments were also to be conducted to find simple forms of programming—as for instance the telecasting of book reviews—which could serve as regular fill-ins on sustaining programs when television goes "full time."

Television turned its electronic eye on this new field recently when it made its first book review, as shown photographically at right. Seated in the N.B.C. experimental studios at Radio City, Ernest Boyd, distinguished literary critic and N.B.C. script writer, gave his review while television alternately showed him at his desk and scanned the pictures illustrating Sidney A. Spencer's "The Greatest Show on Earth," a popularized study of man's economic problems. Note mike over Boyd's head.

As in the period of test broadcasts concluded last spring, the newly announced transmissions were to be divided into 2 series. Film and live entertainment—of which the book review telecast mentioned above was an example of the latter—were scheduled to be telecast twice weekly; and test charts and still pictures, of no entertainment value but of great assistance to experimenters building or testing receivers, to be transmitted 4 afternoons a week, over N.B.C.

(Continued on page 305)



NEW 42-PASSENGER AIRLINER BOASTS SUPER-RADIO SYSTEM

Sub-stratosphere flying in 30-ton Douglas DC-4 super-planes is aided by new radio equipment. Direction-finding, 10-frequency radiotelephony, intercommunication, Bell System telephone facilities, emergency equipment, and simultaneous observation of beacon, weather and marker signals are available.

WHEN the giant new Douglas airliner DC-4, now undergoing tests at Santa Monica, California, roars into the sky with 42 passengers and 3 tons of air express, it carries the most powerful and comprehensive radio telephone yet developed for commercial air transport service.

To the air-minded public this means another long stride toward the goal of completely dependable air travel. Radio, and in particular 2-way radio telephone between the pilot and landing field, has come to occupy such an important position as a navigating instrument, as a means for communicating weather information, and as an aid to flight scheduling and flight control generally, that airline officials now class it second only to the use of multiple engines as a safety device. To those charged with building our air transportation system, progress in aircraft radio as exemplified by the DC-4 equipment also means increased financial security because it enables larger planes, carrying more passengers, to fly longer distances at lower operating costs per passenger mile.

The 250-watt Western Electric equipment installed aboard the DC-4 is 5 times more powerful than conventional airplane transmitters and includes many unique features. For the first time, a flight crew is equipped to make simultaneous observations of the beacon,

(Continued on page 313)



E. A. Post, communications engineer of the United Air Lines Transport Corporation, inspects the DC-4's direction-finding loop antenna by means of which the celebrated 30-ton air giant ascertains its exact position relative to beacon stations. Two additional receiving antennas are installed beneath the ship and its pilot's voice is flashed from a slender wire stretching above the 42-passenger cabin.



Eleven units of radio equipment will ultimately guide the giant DC-4; only 5 are shown here. The radio rack holds (top) the inter-communicating system amplifier; (next lower) the 250-watt transmitter joined through flexible shafting to the communications receiver below it. The auxiliary receiver is seen immediately to the left of the latter unit and below it is the beacon receiver. When aloft, radio operation is governed remotely by a control column.



W. E. Reichle, Bell Telephone Laboratories engineer, tests the radio telephone aboard DC-4, the Douglas super-airliner. The flight engineer's seat, beside which he crouches, swivels into position on a semi-circular track mounted on temporary wooden flooring. All units of equipment slide like drawers into a special rack, and connections are completed through plug-in cables which may be seen extending from a vertical conduit beyond the apparatus.

WIRE-LESS PUBLIC TELEPHONES ON WHEELS!

RADIO-CRAFT suggests how radio may help convert local- and long-distance-telephone booth trucks and trailers into completely "free-lance" units. (See cover.)

ON the cover of this issue *Radio-Craft* has illustrated its suggestion for making mobile public phone booth trucks and trailers completely independent of the cable connection to a nearby telephone pole or other terminal point required up to the present time.

As shown in the photographs at left such mobile equipment, albeit without radio facility, is actually in use. At A is shown the New York Telephone Company's mobile booth truck. At B is illustrated the phone booth trailer of the Chesapeake & Potomac Telephone Company; an interior view—a line of booths with the attendance desk in foreground—of the trailer is shown at C.

The following, more detailed descriptions of these pay stations-on-wheels emphasize the importance of these new means of "bringing the mountain to Mohammed."

PAY-TELEPHONE TRUCKS

A "public telephone truck," containing 5 public telephone booths, was at hand on July 14, when Howard Hughes and his 4 companions landed at Floyd Bennett Field to complete their record-breaking round-the-world flight. These facilities were provided by the New York Telephone Company for
(Continued on page 306)

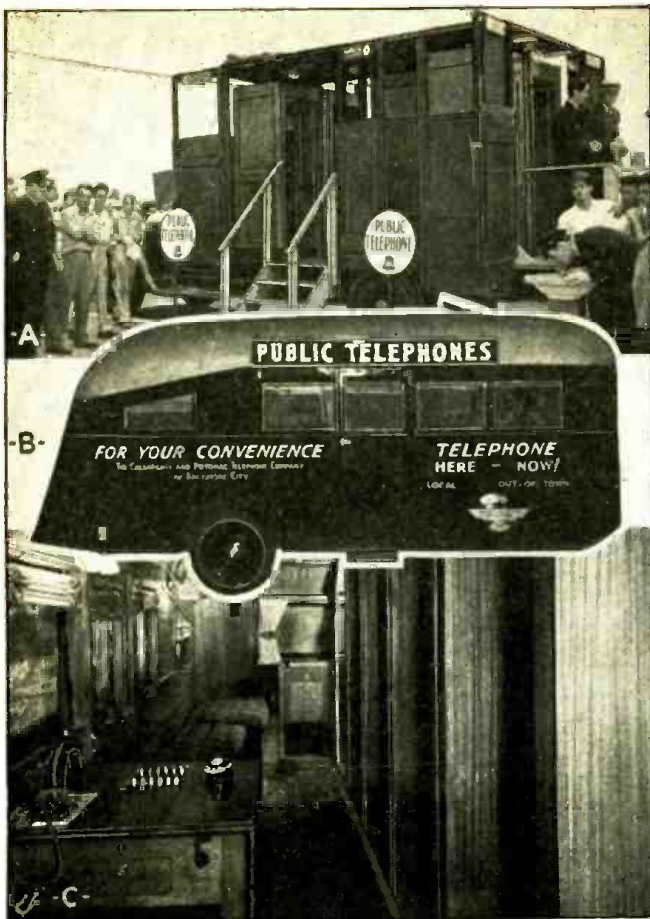

ELECTRONIC ORGAN HELPS DIT-DAH BOYS!

Super-audible and audible frequencies may be used, as an almost limitless number of channels, to send innumerable messages over 1 wire—simultaneously!

A NEW advance in communication, making possible the sending of 96 telegraphic messages in one direction over a single circuit simultaneously, was recently demonstrated publicly by Western Union engineers. The system is now in commercial operation over Western Union circuits between New York and Chicago, New York and Washington, New York and Buffalo. It will eventually be extended throughout the United States.

Once upon a time, the customary method of sending telegrams was for one operator to tap a Morse key and transmit dots and dashes over one wire to a distant point at which another operator would listen to the dots and dashes on a sounder and write the message down. Then inventors found ways of sending two messages over a wire. A former Western Union operator named Thomas A. Edison figured out a way to send 4 messages simultaneously over one single wire. Other inventors went on to perfect the Western Union Multiplex System by which 8 telegrams are sent simultaneously over a wire. And on reception they are automatically printed, ready for delivery. This is the method in general use today to flash messages over our direct trunk lines between the cities of the nation.

CARRIER TELEGRAPHY

The final great development in the growth of the number of telegrams which may be sent simultaneously over a telegraph line was the *carrier current* system which makes



While concert organist Virginia Oman produces a single musical tone on the electronic organ, the operator at the left "codes" the tone with the telegraph message. The tone then goes over regular line along with many others. The tone produced is visually indicated by a pilot bulb on the musical scale of the "Tone Detector" shown at upper-right.

it again practicable to increase greatly the message carrying efficiency of the telegraph wires. The new system is an improved "carrier current" arrangement.

(Continued on page 304)



Exterior view of the complete Radio Trailer of the Legion's Emergency Unit.

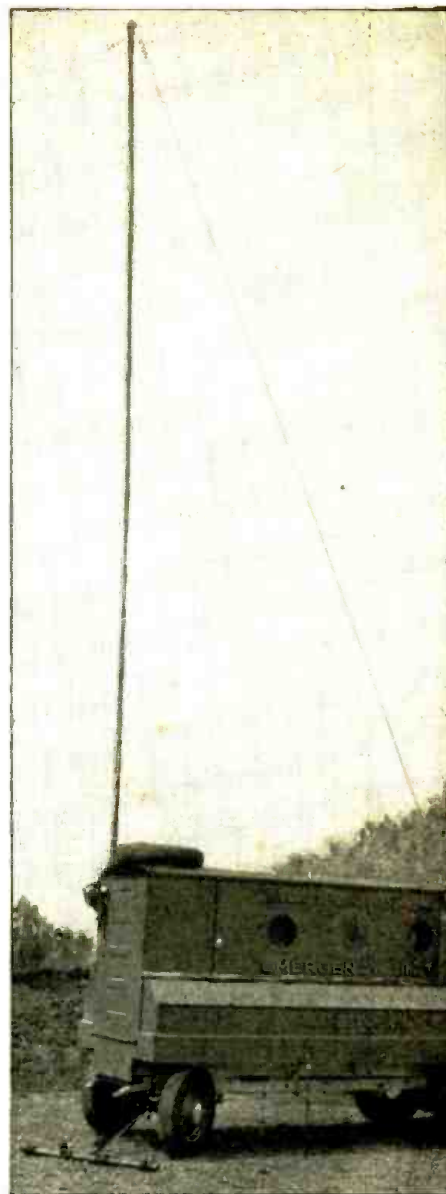

The antenna of station-on-wheels WANC and W8SHO, supported by a tall mast on the trailer, may be set up in jig-time.

EMERGENCY RADIO TRAILER OF THE AMERICAN LEGION

An ex-Major of the U. S. Army Signal Corps tells RADIO-CRAFT readers about a super-radio station, on wheels, for use in national disasters and special emergencies.

THE Emergency Unit of Ira Lou Spring

Post No. 149, The American Legion, Jamestown, N. Y., was organized in 1926 for the sole purpose of rendering service to the community in case of serious public emergency such as a serious fire, flood, explosion or other disaster, serious riot or threatened danger to public property NOT including strike duty.

The Unit is subject to call from the Police Department, Fire Department, the Red Cross Chapter, the County Sheriff and the County Commander of the American Legion.

The complete Unit now has 144 members organized in the following Sections: Headquarters, First Aid, Rescue, Communication, Guard, Transportation, Supply and Auxiliary. The Transportation Section includes trucks and (illustrated) a Unit trailer.

The Communication Section includes radio operators, telephone men, and linemen. Equipment: short-wave radio transmitter, gas engine and generator, 2 radio receivers, telephone switchboard, field telephones, wire, climbers.

Since our Emergency Unit was organized in 1926 (the first such Unit in the U.S.), we have turned out for various duties such as: assisting city police in maintaining fire lines in serious fires, reserve force at time of Red parades, patrol duty at time of serious sleet storms with wires and poles down, cleaning up after flood at Hornell, N. Y., search for lost child, etc., etc.

Our mobile trailer radio station WANC was sent to Indiana when National Headquarters of the American Legion accepted our offer to be of aid

FREDERICK P. ROGERS
Post Mobilization Officer

during the flood. We sent 10 men, and radio trailer-truck WANC with its gas engine and A.C. generator, telephone switchboard, field telephones, wire, tools, 2 weeks' rations, mess outfit (complete), bedding, etc., etc.

We were assigned to operate radio for HQ 76th Brigade, Ind. National Guard, at North Vernon, Ind., and were on duty for a week. We operated in an emergency net under the supervision of the National Guard and the State Police.

We feel that our special emergency radio station-on-wheels WANC would be of great value in time of more serious emergency or disaster. At present there is only one other special emergency radio station owned and operated by a private organization. (Station WAGE, owned by the Lakeside Radio Club, Lake Bluff, Ill., is built in a truck—instead of a trailer like WANC—and the power is 500 watts.) All other stations of this type are owned by state, county or city governments or by public utilities.

Special emergency trailer-station WANC operates on 2,726 kc. (phone, 12.5 watts) and 3,190 kc. (C.W., 50 watts). The trailer also includes a 5-meter set-up for maintaining contact with police radio systems. Emergency power supply is obtained from a 500-watt generator driven by a 1½ horsepower gas engine.

The generator will furnish current enough for transmitter, receiver and several lights in the trailer. We also have a 6-volt emergency light circuit in the trailer operated from storage batteries.

(Continued on page 301)



The radio, and line-telephone and -telegraph equipment are powered by optional generator or storage battery.



1—RECORDING ROOM—First, Miss Arline Blackburn peers through a microscope and helps test the brand new wax disk on which the studio's program is to be recorded. Pretty soon the music comes in over the wires and a delicate stylus bites it into the disk.

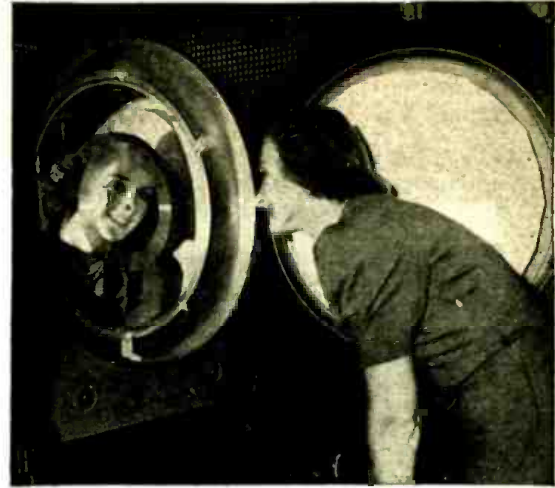

4—SPUTTERING MACHINE—Into vacuum-sealed chamber goes the wax disk, to be "sputtered." That means that for 20 minutes it is bombarded with tiny gold particles, so that it comes out with a millionth-of-an-inch gold plating on every little groove and hollow. And here's Miss Blackburn, checking up on it.

" . . . BY ELECTRICAL



2—CONTROL ROOM—Miss Blackburn, however, doesn't stick around for that. Instead she goes to the control room and watches the engineer manipulate the "mixing panel" by which the proper volume and intensity of sound are blended.



5—COPPER DEPOSIT—After gold, comes copper. The gold-plated disk goes into a solution of copper sulphate. In due time it comes out again, with a layer of nice new copper on top of the gold. Then it goes into this machine, and a thick layer of copper is deposited on its surface.



3—WAX DISK—Next a visit to the recording room, where the stylus has done its work on the nice new wax disk. The engineer hoists the disk off the machine and Miss Blackburn takes a gander at it. The program is all waxed now.

THE radio sputters twice, somebody coughs, and then the unctuous voice of the announcer says that the next program "will come to you by electrical transcription."

What's back of that familiar phrase, anyway? Does it simply mean that somebody in the studio is going to start a phonograph? Where do the radio people get the transcriptions? How do they get them?

Here's a behind-the-scenes picture story to answer those questions. Follow Arline Blackburn, the "Pretty Kitty Kelly" radio star, as she makes a trip through the headquarters of the *World Broadcasting System*, largest makers of transcribed radio programs in the business.

When you have finished the trip you will see that there's a lot more to that transcribed-program business than simply starting a phonograph. One of the most interesting and complicated parts of the whole radio field stands revealed.

This pictorial tour of radio star Arline Blackburn, through *World Broadcasting System's* Transcription Headquarters was prepared by *Benton & Bowles* and printed in *World News*. We thank both these companies for the privilege of presenting this interesting "behind-the-scenes" story to our readers.



6—STRIPPING WAX—Our Arline missed that last step, but she comes back now. Since the copper-backed gold has taken a perfect negative impression from the wax, the wax is no longer needed. So it is stripped off, and a gold-and-copper disk remains. But there's still lots to be done.



9—PRESSING MACHINE—Now we start making records. Disk goes into a hydraulic press, and a "biscuit" of plastic material is put next to it. Comes a ton of pressure—and the result is a perfect duplicate of the original wax recording.

TRANSCRIPTION"



7—TRIMMING DISK—For one thing, the disk has to be trimmed down to size. Miss Blackburn looks on as this is done. (Thus far work has been done only on the master record or transcription.)

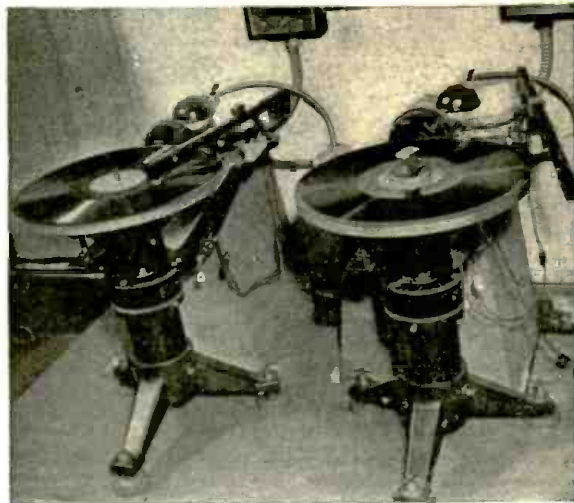

10—PLAYBACK—And now you see the end product of all of this—a couple of recordings mounted on turntables, ready to send the program out over the air. This is what goes on in the studio when you hear "... by electrical transcription."



8—CHROMIUM PLATING—And that isn't all. A technician dips the disk into a chromium bath. It comes out chromium-plated, after which it goes to a drying oven. A final smoothing and aligning operation follows.



11—FINISHED PRODUCT—Oh, yes—here's Miss Blackburn again. She's down in the shipping room now, holding up one of the finished records, whose pound of weight contains 15 minutes of entertainment. Behind her, all packed, are more records, ready to be sent to the stations which are to broadcast them.

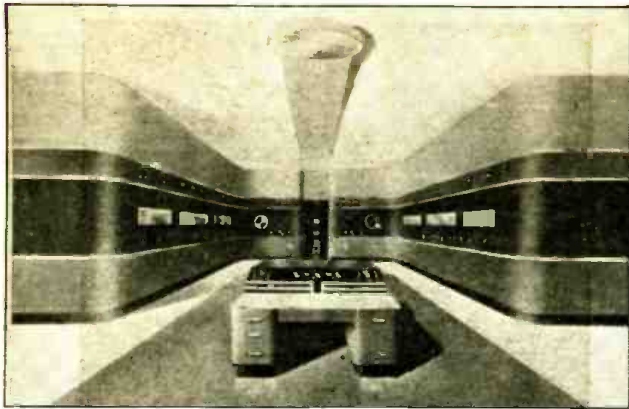

A modern transmitter, the RCA 50-D, designed with its function held clearly in mind and free from unessential decorative detail. This de luxe high-fidelity 50,000-watt transmitter for clear channel stations typifies modern broadcast equipment.

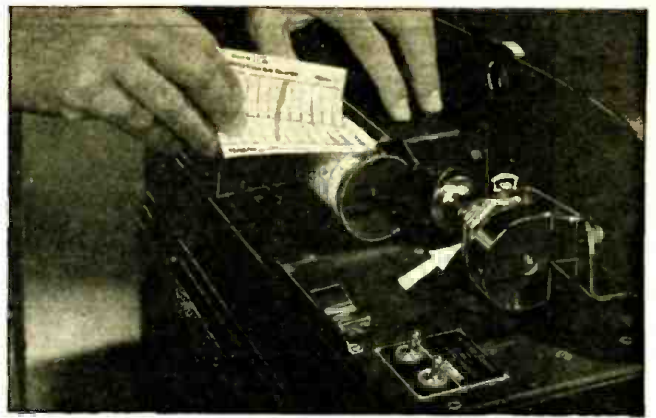

The new Watch Rate Recorder developed by Western Electric Co. checks in a few minutes the performance of any watch (arrow) in any position—and records the result! Saves jewelers many days' time. Unit employs high-gain amplifier. Above, removing record.

DEVELOPMENTS INCREASE RADIO'S VOCATIONAL APPEAL

A review of technical developments, here and abroad, over a period of 12 months reveals the rapidly expanding development of Radio, Electronics and Public Address. Radio is indeed a worthwhile vocation.

VOCATIONAL possibilities in radio (i.e., Radio, Electronics and Public Address), of which broadcasting is only a part, are almost limitless; and, like the roots of a great tree, are rapidly increasing in number and variety. It is difficult, however, for the average radio man, let alone the newcomer, to realize the tremendous scope of this field. For this reason, the following, easily-readable article on how radio has climbed another rung of development during recent months, will help visualize the money-making possibilities in numerous activities which depend upon radio equipment and technique.

Bear in mind, radio is not going to sleep, it's not even marking time. Instead, it's rapidly surging ahead. However, the energy that once was so apparent as rapid growth in a few directions, today, is less evident but even more active—but in a great many directions at once. Radio most fortunately has at last drawn to it engineering, business, industrial, research, executive and labor personnel of the highest calibre; and capital has finally realized that radio is not only an active, progressive field, as compared to older ones, but also sufficiently stabilized to warrant large investments.

The following resume of material on radio for the year 1937, both in the U.S. and in countries outside of the United States, is of unusual interest in view of its exceptional completeness. Part of the material represents operations of International Telephone and Telegraph Corp. companies, but also included is information gathered from government administrations and other private companies throughout the world. Although certain of the items mentioned here have been touched-upon in considerable detail in recent issues of *Radio-Craft* the few sentences they comprise are retained for completeness; space limitations having precluded running this resume in an earlier issue.

TELEVISION

In the field of television the year brought forth no startling changes. Progress, however, has been consistent.

The British Broadcasting Corporation standardized on the Marconi E.M.I. system and has ceased transmission with the Baird system. Programme time is now 3 hours daily, a large part of the programme being direct vision by means of the Emitron camera.

Some 14 manufacturers showed television receivers at the 1937 exhibition at Olympia (London). The prices ranged from £38 to £125.

In France the old television equipment has been entirely replaced by modern studio and transmitter equipment, capable of giving 455 lines. Direct or film signals are used with the pick-up located either at the P.T.T. studio or at the Radio Palace at the Paris Exhibition. A vision transmitter of 30 kw. peak power, supplied by Le Materiel Telephonique, Paris, has been installed at the base of the Eiffel Tower and has been connected to the antenna at the top by a concentric cable. The vision transmitter operates on 46 megacycles and the sound transmitter on 42 megacycles.

In Germany the Berlin 15-kw. transmitter has been sending a 180-line picture, but it is planned to change to 441-line interlaced transmission using positive modulation, the D.C. component, only, being transmitted. Three new transmitters are reported to be planned: one on the Brochen, the highest point in the Hartz mountains; one on a peak near Frankfort, and one near Berlin. Work on the first is understood to be well advanced. Receivers with cathode-ray tubes 25 inches in diameter are used, the 14 x 16 inch images produced being reported as brighter than ordinary moving pictures!

E.I.A.R. (Italian Broadcasting Co.) is understood to be considering the installation of a 30-kw. (peak) video transmitter in Rome. It has been stated that Russia has placed an order for a complete studio system and transmitter with RCA.

There has been an advance in the intermediate film pick-up by Fernseh, A. G. By means of a special process, a film scanner has been produced which photographs, develops and transmits the picture within 16 seconds of the action.

The new N.B.C., Washington, D.C., studios, opened in 1937, include television equipment. Extensive provision has been made for visual broadcasts.

Wide publicity is given periodically in the popular Press to television programmes being received at great distances. Such reception, however, as is well known to technicians, is of a distinctly freak nature, the range covered reliably being of the order of 30 miles. Since television programmes are expensive, it seems obvious that television for some time to come at least will be dependent on coaxial cables for distribution purposes.

PICTURE TRANSMISSION

Both fixed and portable installations for picture (facsimile) transmission are being employed increasingly by newspapers. Simplified systems for transmission of maps are being used in connection with weather forecasting.

Interesting results have been obtained with apparatus developed by the Laboratories of the Nippon Electric Company, Tokyo. A special type of modulation avoiding to a large extent the effects of interference is employed.

COMMERCIAL RADIO

The year 1937 was characterized by an increasing demand for commercial radio facilities. An outstanding feature of new transmitters was the incorporation of facilities for rapid changes of wavelength. In England and America this tendency, combined with the demand for simpler control, has led to the extension of impulse controls operated by a telephone dial.

Ultra-shortwave operation continues to be the direction in which commercial radio is advancing most rapidly. Its extension is in some cases due to the highly efficient aerials, which may be erected without excessive cost, and to reduced atmospheric interference; and, in other cases, to the possibility of transmitting wide bands of modulation frequencies.

Multi-channel operation of radio links has been brought into the practical field of communication by the use of these properties of ultra-shortwaves. Nineteen hundred and thirty-seven marks the introduction for the first time of a multi-channel unattended, remote-controlled radio link in the regular long-distance telephone network.

One of the most important developments of the year abroad is an ultra-shortwave radio telephone circuit which transmits 9 completely segregated, 2-way telephone conversations simultaneously, the first radiotelephone installation of this capacity in the world. It has been established by the British Post Office between Ireland and Scotland. Standard Telephones and Cables, Limited, an associated company of the I. T. & T., which developed the system in collaboration with the engineers of the British Post Office, engineered, manufactured, and installed the system.

It is applied on one of the busiest telephone pathways in Europe connecting the telephone system of Northern Ireland with that of England and Scotland and, through London, with the



Ladies and gentlemen—meet Bell Tel. Co.'s "bliffy sniffer"! Nearly as we can make out, the "bliffy" is an amplifier and the "sniffer" is a prod which noses-out a "live" wire. In old system, a tone put out a wire (one of a number in a telephone cable under test) at a remote point was "buzzed-out" with earphone and contact prod until tone was heard. In new scheme, prod merely comes near the wire.

rest of the world. The radio link covers 41 miles over the North Channel of the Irish Sea between Belfast, Ireland, and Stranraer, Scotland.

The 9-channel ultra-shortwave system is the culmination of 6 years of intensive research and development work by laboratories of I. T. & T. subsidiaries in France and England which have pioneered the application to radio communication of micro-rays (tiny radio waves of about 10 centimeters) and ultra-shortwaves (wavelengths of less than 10 meters).

The Press has mentioned the possibility of the installation of two more similar links connecting Dover and Calais, thus furnishing a further 18 telephone channels between England and France. Simpler, single-channel equipment has been used off the coasts of Scotland for extending telephone facilities to the nearby islands, since the character of the service does not warrant the high cost of installing submarine cables.

Plans involving the operation of long-distance international links have been influenced by the drop in field-strength which is expected in the year 1940. Periods of severe attenuation have already been experienced on trans-Atlantic circuits and have caused a demand for the erection of high-gain directional aeriels. On account of its wide-band operation, the rhombic aerial has been favored in meeting this demand. Such aeriels have recently been installed at Geneva, Budapest, Bangkok and Durban, and it seems likely that further installations will be made to replace tuned arrays now in operation. This possibility, taken in conjunction with rapid band-changing by means of telephone dials indicates the trend towards simplifying the operation of transmitters. By eliminating the necessity of mechanical adjustments to the transmitter itself and of switching the aeriels, the operator is left free to concentrate on the handling of the circuit. Moreover, the provision of complete remote control of the transmitter is rendered easier.

On international links of first importance high-gain aerial systems are already in use, but it is anticipated that at about the year 1940 a dozen decibels (db.) of additional gain will be needed for 40 per cent to 50 per cent of the time during sunspot periods in order to maintain the circuits at a commercial level. Since the average transmitter carrier power is already of the order of 15 kw., still more gain in the aerial systems is economically justifiable. The older types give no certain improvement in operation beyond a gain of the order of 14 db. since the vertical polar diagram thereafter becomes too sharp.

The Bell Telephone Laboratories have, therefore, developed for receiving purposes, the Multiple Unit Steerable Antenna (M.U.S.A.), information on which was published during the year. This system gives much greater directivity in the vertical plane since the wave angle is continuously adjustable by the rotation of a suitable control system. Estimates suggest that a system incorporating 20 rhombic aeriels and extending over a length of 2 miles would be practicable and would give an improvement of 12 to 13 db. in signal-to-noise ratio over directivity of this system enabling it to respond to only one wave of a downcoming cluster at a given time; it, therefore, goes a long way towards

eliminating telephone distortion caused by selective fading. In addition, several receivers may be supplied by the one aerial group, being adjusted to be sensitive at different wave-angles. By combining the outputs of these receivers in a diversity system, a stable audio channel is obtained and, at times of bad fading, gives a surprising improvement in quality over single-aerial and space-diversity systems.

The M.U.S.A. aerial system is a fundamental development in the short-wave art since it gives promise of overcoming selective fading by arriving at its component causes. The play of economic factors on the commercial application of this system will be watched with interest.

POLICE RADIO

A number of medium- and shortwave systems are being installed in Great Britain, Czechoslovakia, Palestine and Egypt but the most significant development is the introduction of ultra-shortwave for this service.

During 1937 there was a considerable increase in the use of these systems in the U.S.A. and some areas are now served by U.S.W. systems of Western Electric or RCA manufacture.

In Europe, demonstrations of the system have been made in a number of countries and the system is being installed in Austria, Norway and Finland, while it is anticipated that U.S.W. for local area coverage will be adopted in other police networks. The great advantage of U.S.W. working is that 2-way telephone communication can be maintained with mobile units equipped with small, lightweight transmitting and receiving sets.

It seems probable that the future trend of



The Annual Amateur Athletic Association Championships held recently at White City, London (Eng.), inaugurated the use of a pack transmitter to radio the results to the scoreboard control.

police networks will be the use of U.S.W. for local area coverage and medium- or shortwaves for long-distance and international working.

MARINE RADIO

The installation of shortwave transmitters is proceeding at a rapid pace and practically all new ships built for overseas service now employ shortwave communication equipment.

This policy of the ships' owners will result in great increase of traffic in shortwave marine bands with consequent interference between ships and shore stations. Many operating organizations, therefore, are introducing crystal-controlled, shortwave transmitters along lines recommended by the International Marine Radio Company, Ltd., London, several years ago.

The Swedish Administration has completed its design of a new ship's transmitting equipment which is provided with 6 crystal-controlled frequencies. All power from the transmitter is taken from an A.C. generator and rectified by means of selenium-type rectifiers.

By its ratification of the recommendations of the "Safety of Life at Sea Conference", held in London in 1929, the U.S.A. Government now

(Continued on page 298)

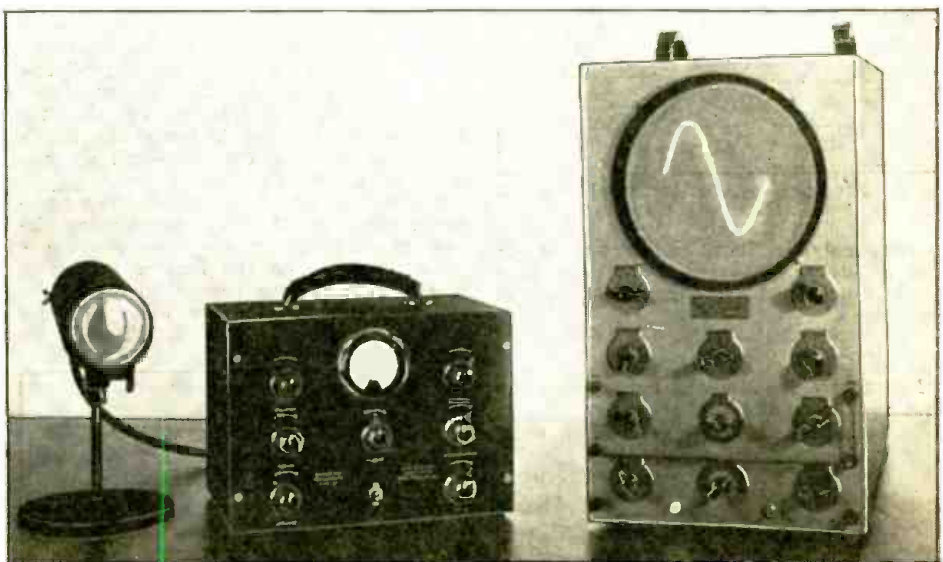

Oscilloscopes have come a long way in 6 years, haven't they? Now no lab. is complete without one. At left and center is a job that sold for \$250; today, a far better unit could be bought for a quarter the price. A modern, completely self-contained Du Mont 9-in. oscilloscope is illustrated at right; it can do more tricks than a magician. Its equipment like this modern test device which has helped give such an impetus to radio, and given it such an enviable reputation as today's No. 1 vocation.

OPERATING NOTES

ANALYSES of RADIO RECEIVER SYMPTOMS

SERVICEMEN—What faults have you encountered in late-model radio sets? Note that RADIO-CRAFT will consider your Operating Notes provided they relate to characteristic (repeatedly encountered) faults of a given set model. Payment is made after publication of the Operating Note.

Trouble in . . .

STEWART-WARNER R-110

An A.V.C. action that is responsible for plopping-in of stations as the dial is turned may be made to work in a more satisfactory manner by changing the A.V.C. resistor in the grid-return lead of the R.F. tube from 200 ohms to 50,000 ohms.

If trouble is experienced with instability and oscillation all over the dial, the rotor connections or pigtailed should be tightened and a bus wire run from the contacts to a good chassis ground. The rotors have only a fine copper band from a bolt on the condenser frame to chassis for a ground which is too high in R.F. resistance.

HALSON 25

Distortion in this model is caused generally by a low-emission output tube, open filter condenser, or high-resistance open in the plate lead of the 75 audio driver. Oscillation may be traced to poor chassis ground connections of the several paper condensers used as R.F. filters, particularly those going to the I.F. stage. Poor sensitivity is generally indicative of a need for alignment, especially when the preliminary tests have shown the

vibrator which must be placed so that the polarity of the lead to the ammeter is right. Otherwise, the ammeter of the car will indicate an excessive load and the set will not operate. This was found in an early

noticed a 400-volt surge on the R.F. plates. Why?—these sets operate on a little over 100 volts on the R.F.; Cause—An open 10,000-ohm, 50-watt W.W. resistor connected from the load side of the speaker field to chassis. Had not we checked this—OH BOY! (Note. When aligning these sets, often it is best not to peak them too well, as you will be unable to tune down strong locals.)

PHILCO 37, 84

Complaint—very low volume. A check revealed that there was no voltage on the S.-G. of the 6J7G, combined osc. and 1st.-detector tube (See Fig 2). A further check showed an open 16,000-ohm resistor, A, and a shorted 0.09-mf. bypass condenser, B. Replacing with a 3-watt, 15,000-ohm resistor and a 0.1-mf., 400-volt condenser, will clear up all trouble.

In many of these sets the resistor, A, is not always open, but it is a good idea to replace it, too. The initial trouble is that condenser, B, breaks down—however, the set will play some anyway, and the customer usually has run the set quite some time in this condition—hence the resistor has be-

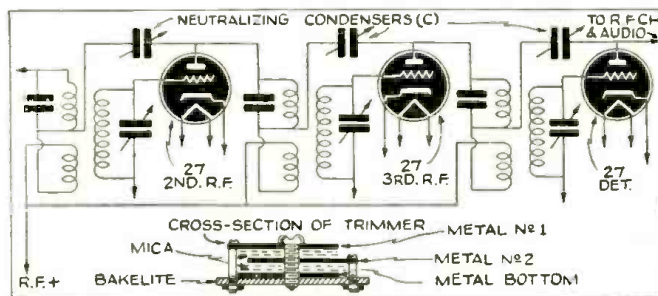

Fig. 1. Defective neutralizing condenser (C) in Edison 7R.

Packard and will undoubtedly be encountered in numerous other makes. Also, the adjustment of the antenna trimmer when the set is installed is important; noise, along with weak signals, giving way to clearer reception.

Loose wires on under side of chassis should be checked, cuts out noise.

WILLARD MOODY

EDISON 7R

This set came in with the complaint of distortion and noise. After checking the tubes and hooking up the set, a sputtering sound emitted from the tuner chassis followed by a growl from the loudspeaker. After warming up, the stations came in very weak accompanied by a loud noise and had distortion, indicating an arc somewhere. Then there was a loud "pop" and everything worked normally—and continued to do so until it was turned off, then the same trouble recurred. Searching for a visible arc proved fruitless—and all voltages were within reason.

The trouble was finally located in a trimmer condenser (C) in the neutralizing circuit (Fig. 1). As these condensers have an extra plate on the bottom (where it was arcing) it was impossible to see the arc. Insertion of a new piece of mica (Fig. 1) fixed it all OK. But then we

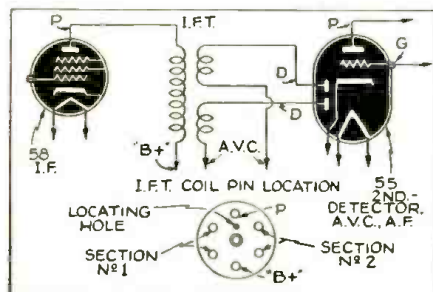

Fig. 3. I.F. transformers in Majestic 460, 450 defective. Replace both I.F. units.

power supply circuits to be in order, assuming, of course, that the tubes have been checked at the beginning of the service operations.

MOTOROLA 90A

Frequently found to be inoperative, the first indication of trouble is generally the faulty or non-operation of the "tuning eye." This is usually found to be a direct result of a short-circuit to chassis or ground through the filter from the screen of the 6V6 output tube.

G. E. FA-80

Non-operation of this set may upon installation in the customer's car be found to be the result of incorrect insertion of the

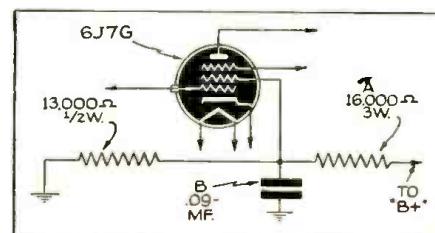

Fig. 2. Screen-grid resistor opens and bypass condenser shorts in Philco 37, 84.

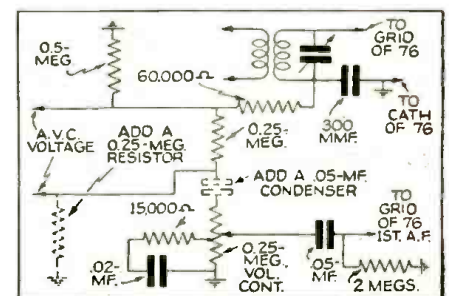

Fig. 4. Method of isolating the volume control in RCA-Victor 262, 263.

come carbonized, and if it is not replaced along with the condenser—a bad case of distortion may ensue. There should be 100—110 V. on S.-G.

RCA 44

I recently had the experience of replacing the power transformer on an RCA 44. After installing the transformer and trying it out for a few minutes, the tone became badly distorted. Shutting it off for 15 minutes would make it play OK for a short time and then more distortion. As everything else was absolutely all right I experimented with the bias. Replacement of the 2,000-ohm bias resistor on the single 45 output tube helped none at all, but upon increasing the

(Continued on page 317)

SERVICING

QUESTIONS & ANSWERS

Servicemen may write, requesting answers to specific service questions. Address inquiries to Service Editor. For questions answered by mail, a service fee of 25c per question is made. Only questions of wide interest can be published.

INTERMITTENT RECEPTION

(83) Albert S. Cain, Bremen, Ga.

(Q.) I have a Zenith model 6S128 for repair; the complaint is—intermittent reception. The tubes check OK. New tubes have been tried, everything checks OK, but the trouble continues. Sometimes it will play perfectly for a day or so, then it will cut off and stay off from 2 to 10 seconds and pop back on; sometimes it gradually goes off, then pops back. During these spells it has a noise like dropping a book on a table repeatedly. The volume also drops; it takes more volume than when it is operating OK. Could it be the candohm voltage divider? Please help me with this set.

(A.) This trouble has been traced to the voltage divider, the volume control, and the audio coupling condenser.

The voltage divider may be checked by pulling firmly upon the lugs during operation and working the lugs gently back and forth. Poor internal contact of the volume control and coupling condenser is frequently the cause for the trouble described. Try tapping the condenser and tugging lightly at the terminal leads during operation to locate the source of trouble.

SET WHISTLES

(84) Leo L. Bowman, Lewistown, Mont.

(Q.) The set is a Crosley auto-radio model A-366. The set plays very well, but when tuned to our local station (150 miles away) it has a whistle (a heterodyne whistle, I would say) and only at this frequency of 780 kc., KGHL, Billings, Montana. By connecting input to grid of the 6A7 tube and bypassing the R.F. plate to the chassis there is no whistle.

Any assistance you can give will be greatly appreciated.

(A.) The whistle at resonance to a local station is probably due to feedback. We suggest the following procedure to correct your difficulty.

Shield the antenna lead to antenna coil. Shield the 6A7 and I.F. plate leads. Ground shields. Should this fail to accomplish the result desired, it will become necessary to shield the diode I.F. filter resistor and condensers. It is often possible to mount these latter components under a separate shield or under the 2nd I.F. transformer shield. Finally, try a shielded 5 mhy. choke in the R.F. grid-return as close to this stage as possible.

NEW COIL RESULTS IN "SQUEALS"

(85) Fred Olin, South Easton, Mass.

(Q.) I have a Colonial model 52 for repair which had a burned-out primary on the antenna coil. I replaced the coil with a universal replacement coil but it did not work well, so I re-replaced it with an adjustable iron-core coil. This resulted in exceptional

volume, but I get squeals all along the dial, some of which disappear as the station is tuned-in, but most of them do not. Have spent considerable time trying to get this set aligned. Would you suggest a different coil? If so please tell me exactly what to get. This set formerly worked perfectly.

(A.) It would seem that coupling between primary and secondary of antenna coil is too great. We advise that you try increasing the distance between these two windings, if this is at all possible. Try a 100 mmf. or 250 mmf. condenser in series with the antenna to reduce signal input to the antenna coil. Are grid leads shielded?

Re-align receiver completely, but pay particular attention to the R.F. and 1st-detector trimmer adjustments. Of 2 settings possible for highest output, use maximum capacity. Are the tubes shielded?

PLEASE LET US KNOW . . .

. . . whether the problems published in this department are your problems; whether they help you in your daily service work; whether they are instructive in character, thus helping you to better understand radio. Servicemen, this is your department, so please let us have your ideas and opinions. Address all letters to the Service Editor.

SENSITIVITY TROUBLE

(86) D. E. Greathouse, Larned, Kans.

(Q.) I have had trouble with a Chevrolet auto receiver. When I align the gang condenser for maximum sensitivity at the high frequencies, the low-frequency end of the broadcast band becomes very insensitive. The trimmers for the R.F. and 1st-detector stages are "open" when this is done. However to secure good sensitivity on the low-frequency end of the band, these trimmers must be screwed down. What do you believe is the trouble?

(A.) It would seem that careful and accurate alignment is the solution. Re-align the I.F. transformers with a signal generator after the receiver has been operating for 15 minutes or more. Since you do not mention the model receiver in question, the correct intermediate frequency cannot be given. Go over the I.F. adjustment several times.

Now tune the receiver to 1,400 kc. and adjust the high-frequency oscillator trimmer so that a 1,400 kc. signal is heard at this point. Two settings of the trimmer may be obtained. Employ that setting of minimum capacity. Adjust the R.F. and 1st-detector trimmers for maximum gain. If 2 settings are obtained, use that of maximum capacity (plates down). If a paddler is used, adjust at 600 kc., then go over the adjustments.

MULTIPLE FAULTS—FREQUENCY DRIFT

(87) E. S. Aitcheson, Kingston, Jamaica, B.W.I.

(Q.1) I have in my shop a Silver-Marshall

Z13; about 6 months after the set was bought, it "shot" a 12 mf. filter condenser and since then "shot" all replacements, also 2 power transformers supplied by the makers of the set! These transformers delivered 525 V. on each plate of the rectifier (5Z3). Have replaced this P.T. with Thor-darson heavy-duty transformer giving 500 V. to each plate of 5Z3. The field coil now heats up badly. The set motorboats when the volume is turned up, reception still weak and will not operate above 10 megacycles without frequent changing of the oscillator tube (56). Tried changing oscillator grid resistor and condenser.

(A.1) With regard to trouble with the Silver-Marshall receiver, since tube voltage data were not submitted, diagnosis is difficult. However, from the symptoms reported, it would seem that the cause for motor-

boating and lack of volume is due to improper screen-grid voltage. We advise checking the voltage divider network. It is important that correct screen-grid voltage be applied in this receiver. More particularly, check the resistor or section from screen-grid voltage tap to chassis for open-circuit or change in resistance. Plate voltage on oscillator should be

approximately 240 V.

(Q.2) I have a Knight 11-tube A.M.T. also, that will not remain on the stations at the high-frequency end of the short-wave band: W3XAL, 16-meters, is tuned-in and the pointer is moved for quite a good distance on the scale with the signal growing stronger and the tuning eye closing. If you continue, the station snaps out and you have to turn back to where it was first picked up, a distance of more than 1/4-in.; and if you let it remain where the station is strongest, it plays for a while, then snaps out, never to return again until retuned.

Motor vehicle ignition interference aggravates the condition.

I have tried alignment, and new tested tubes, but all to no avail.

(A.2) Frequency drift on the Knight 11-tube receiver may be due to several causes. We suggest that connections to the I.F. transformer lugs be re-sweated and re-soldered. Re-align the I.F. transformers after the receiver has been operating for more than 15 minutes. Clean the wave-band switch contacts with a stiff-bristled brush and carbon tetrachloride. Clean, likewise, the gang condenser rotor contacts. Check the bonding leads from gang condenser to chassis.

DOUBLE TUNING

(88) Carl H. Johnson, Arlington, Va.

(Q.) I had to replace the oscillator coil in an Emerson 6A-auto receiver. The new coil was purchased from the Emerson Com-
(Continued on page 317)

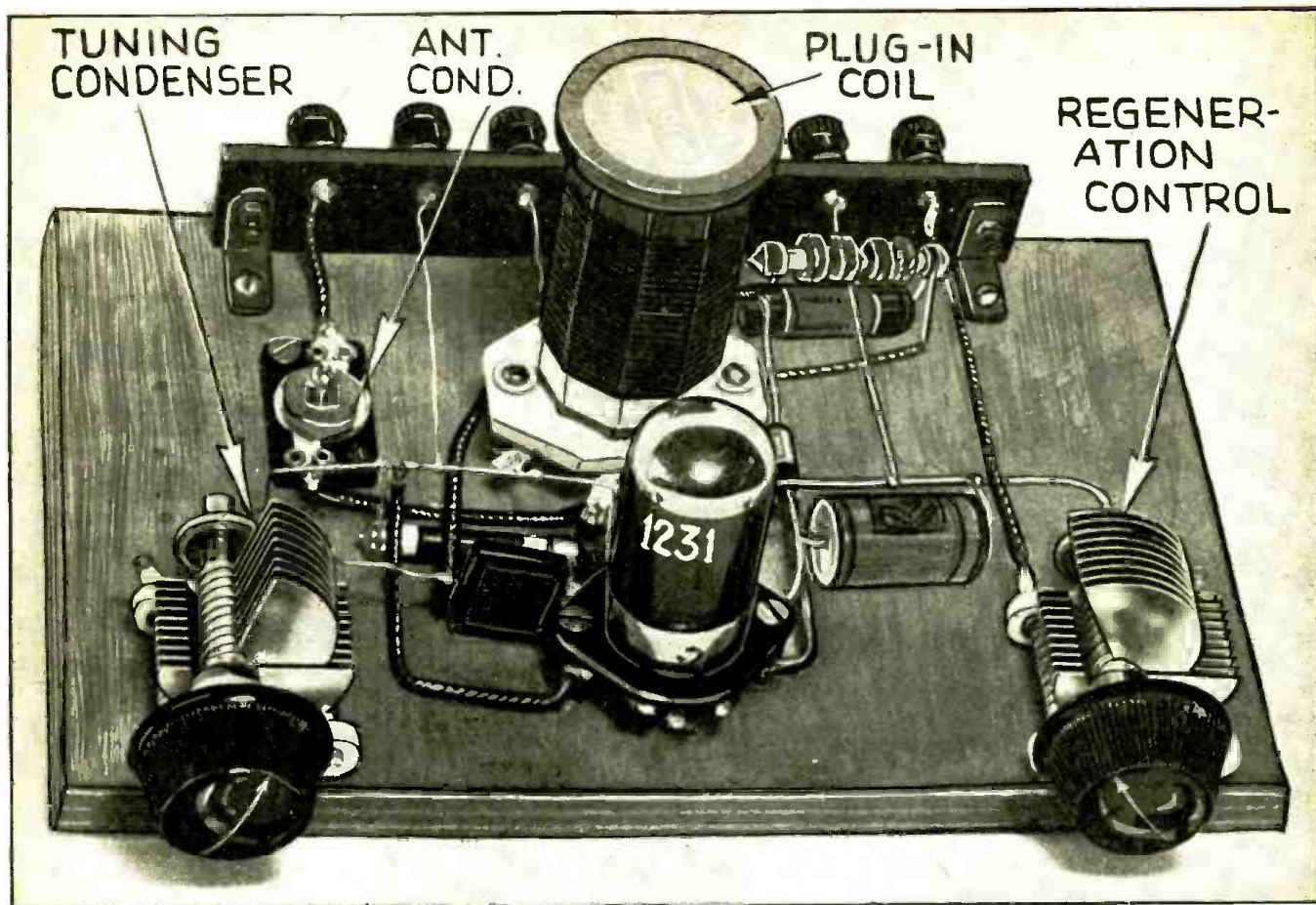

Fig. A. Here's the 1-tuber; perks beautifully on b'cast and all short-wave bands; uses new type 1231 television tube as high-gain detector.

BUILD THIS BEGINNER'S A 1-TUBE HIGH-GAIN

The high amplification characteristic of a television amplifier tube is used as it easy to build this set on a breadboard. The new wafer-thin crystal head-

N. H.

IF there is anything a radio editor likes a little less than a toothache it's being told to design and construct a new receiver just when the magazine is ready to go to press. Such was the fate of the writer. Something new, something good, something that is a lead-pipe cinch for the beginner to construct—and all at a minimum cost.

We then took a saw, a hammer, some midnight oil and a trip to the cellar workshop.

We were fortunate enough to find a decent board from which we buzzed off a piece measuring about 6 x 10 ins., we had a baseboard! Searching through the junkbox we had enough luck to find a binding post strip with 7 binding posts thereon, and a length of hookup wire.

That formed our foundation kit—all we had to do was get the parts, a list of which concludes this article.

PLACEMENT AND WIRING

First, we mounted the 2 midget variable condensers about equidistant from the ends of the panel, as seen in Fig. A. Halfway between them we mounted the special socket for Sylvania's new 1231 television tube, and about an inch behind it, the isolantite-type socket for the 3-circuit plug-in coil.

A length of copper bus was used to connect the requisite coil terminals, tube prongs and condenser rotors to ground, thus getting rid of about 25 per cent of the connections at a single lick. A pair of lengths and push-back wire were then twisted together for the filament circuit, and we felt that the set was practically complete. All that remained was to connect a trimmer in the antenna lead and to wire the grid and plate circuits as shown in circuit diagram Fig. 1. Another half-hour saw that

job done and the set finished, but . . .

We then learned that we had forgotten the condenser stators, so hooked them up, too. Finally we connected a 0.1-mf. condenser between the plate and one of the output binding posts as we intended to use crystal phones which, of course, might have been damaged by the passage of plate current.

After all this was done we connected the 6-V. filament battery where it should be and saw that the filament lit. We next connected the same battery across the "B" terminal and were overjoyed to find out that the filament did *not* light. This is a test we always make and it has saved us enough money in tubes so that we could buy a yacht if we hadn't spent the money for something else.

Everything having checked OK, we applied the "B" voltage and were dis-

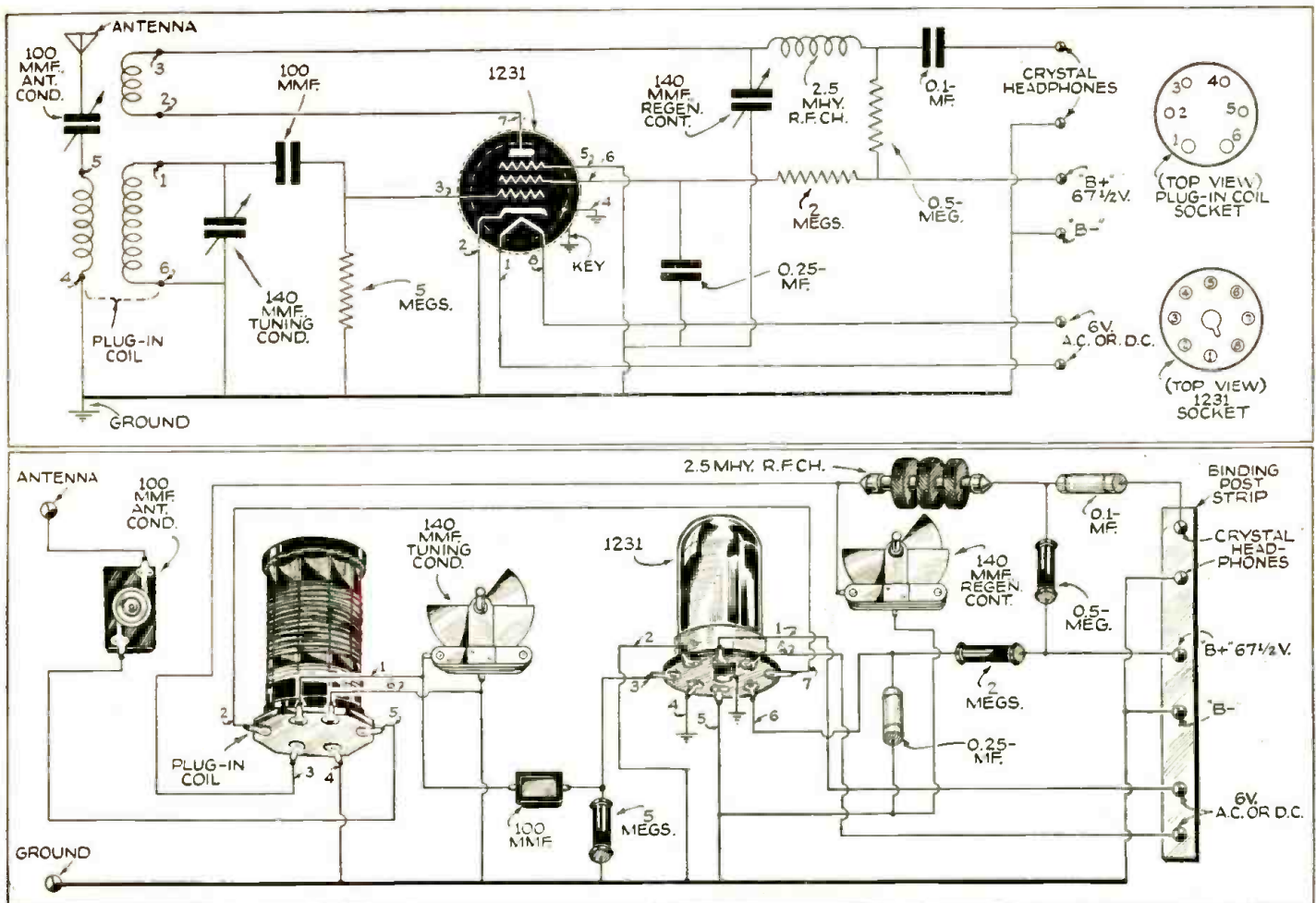

Fig. 1. The circuit is straightforward regenerative, with high-gain 1231 detector. Note that the socket numbering is not R.M.A. but arbitrary.

"BREADBOARD SPECIAL"

ALL-WAVE RECEIVER

the basis of this novel, regenerative receiver. A pictorial diagram helps make phones can be used if maximum DX (long-distance) reception is desired.

LESSEM

mayed to get no results. We sat down and checked the set and found out that we had forgotten to attach the aerial and ground. When we put them on, the stations began coming in like poor relations during a depression—gangs and gangs of them, one right after another. The stations logged with merely a piece of wire hanging out of the window included those of the 20-, 40-, 80-, and 160-amateur bands, as well as broadcasting stations.

Thus we found that we had constructed a pretty decent 1-tube, all-wave battery receiver.

Then, at 4 A.M. in the morning, we sat down to write this article, which as you'll agree, is pretty "whoosie".

DETAILS

The excellent success of the set we may attribute mainly to the use of the

new 1231 video amplifier tube. This high-gain television tube is here used for the first time as a high-gain detector. The volume which this little set afforded in a modern steel building and with only a short wire dangling out of the window as an antenna, is amazing. Broadcast and short-wave stations alike, including code, came in with remarkable clarity. Regeneration was smooth and easily controllable. Secondary credit for excellent performance must go to the high-quality parts used. In order to keep R.F. losses at a minimum isolantite-insulated variable condensers and coil socket were used as well as low-loss plug-in coils. Tertiary credit should go to the author for his excellent design and construction (hi!).

The radio beginner has a real mark to shoot for in this 1-tube all-wave battery receiver—but he shouldn't stay up

until 4 A.M. in the morning building it.

As soon as we send this article through to the printer we are going back to the television baby and see if we can tune in Dakar, Rabat, Istamboul, and Pago-Pago.

List of Parts

- Two Hammarlund type MC-140-M variable condensers, 1.0 mmf.;
 - One set of Hammarlund Short-Wave plug-in coils, type SWK-6, 17 to 270 meters;
 - One Hammarlund Broadcast plug-in coil, type BCC-6, 250 to 560 meters;
 - One Hammarlund R.F. choke, type CHX, 2.5 mhy.;
 - One Sprague 0.25-mf. fixed condenser;
 - One Sprague 0.1-mf. fixed condenser;
 - One IRC carbon resistor, 5 meg., ¼-W.;
 - One IRC carbon resistor 0.5 meg., ¼-W.;
- (Continued on page 300)

FIFTEEN

The mushroom growth of the radio field, engineering activity, has resulted in an

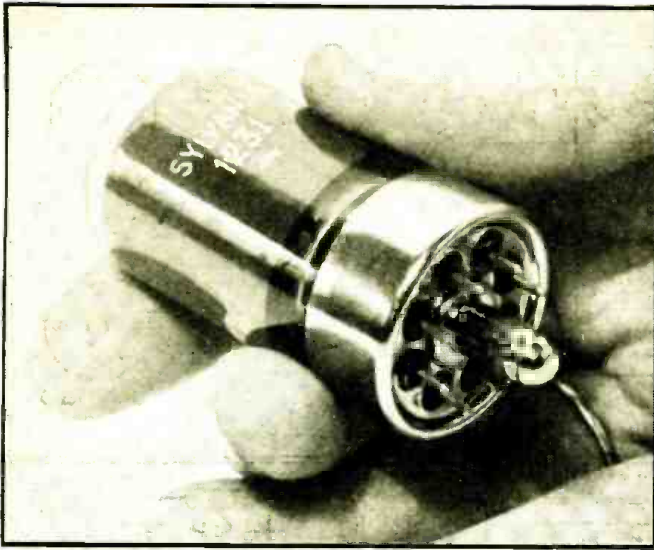

Fig. A

THE lay mind cannot possibly hope to grasp the limitless number of combinations possible in vacuum tube construction (or, "electronic design"). For that matter, it is with little less than stupefaction that the average radio man witnesses the influx of myriad electron devices—control tubes, amplifiers, oscillators, rectifiers, etc., etc.

Most radio men feel, deep down in their hearts, that it's all "a lot of boloney"—that we have enough tubes now—and that there's no sense in adding to the list of hundreds now available.

But that's a shortsighted, obstructionist viewpoint. The fact of the matter, as every advanced technician is aware, is that every little improvement, every new idea in tube construction, often opens up a whole realm for research, thus making possible heretofore unattainable results of considerable importance.

In an abbreviated review of this nature it is not possible to bring out the above points; we can only start from scratch and proceed, rapidly, on the premise that the majority of *Radio-Craft* readers will be interested, first, in just what new tubes have been announced since the last article on tubes, and secondly, just what services these tubes are to perform. If the reader finds that he wishes to know more about a particular tube mentioned in the generalized description, then detailed data, curves, etc., may be obtained from the manufacturer. Now, on with the dance!

1231

The type 1231 tube is a new triple-grid amplifier with unusually high mutual conductance and is further characterized by a number of novel constructional features. It is introduced primarily for use in television video amplifiers and other similar applications.

In physical dimensions type 1231 is considerably smaller than standard glass tubes. Overall height is only 2 7/8 ins. The new construction also provides very short leads to the

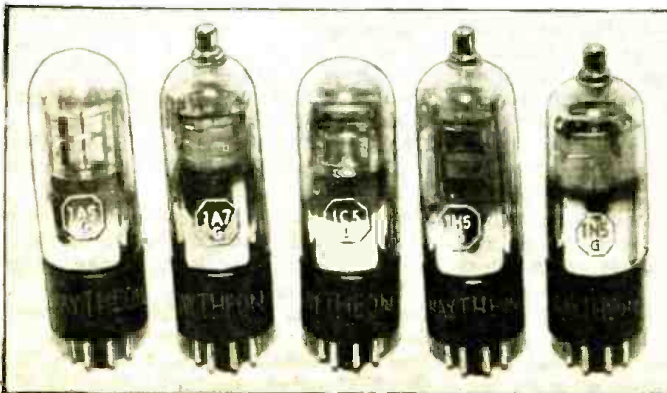

Fig. B

electrodes, low interelement capacity, and low-loss insulation throughout. The leads through the glass bulb serve as the contact pins and also as rigid supports for the mount. This minimizes the number of welds and entirely eliminates pin soldering and any attendant socket difficulties.

No regular base is present. Instead, the lower portion of the bulb is fitted with a metallic shell thus providing for the first time a guide pin of metal which makes possible a positive locking-in action in the socket.

The shell also serves as a shield and, in conjunction with the internal shielding, provides an arrangement which is highly effective.

The control-grid connects to pin No. 6, thereby permitting the use of much shorter C.-G. leads. This eliminates the troublesome flexible connections and clips required with "top-cap" types. Ample shielding is provided for this grid connection inside of the tube; and, the metallic guide pin acts as a shield between the external grid and plate leads. See Fig. A, Table I, and Fig. 1. A Sylvania tube.

NEW SERIES OF 1.4 VOLT BATTERY TUBES

A long-felt need for a series of low-drain battery tubes has finally been fulfilled by Raytheon's series of 5 new 1.4 volt battery tubes. They consume but 0.05-A. and a single flashlight cell is sufficient to operate them for some time. Watch the portable battery sets take a spurt! The tubes, of course, are of the "direct filament" type, and usable only on D.C. The base and glass bulb are of uniform diameter—1 3/16 ins.; and with little variation in height.

1A5G

The 1A5G is a pentode-type power amplifier tube designed for service in the output stage of receivers operating from a low-voltage battery filament supply. See Fig. B, Table II and Fig. 1. Overall height is 4 ins. A Raytheon tube. Sylvania has since announced the same type number.

1A7G

The 1A7G is a pentagrid-type converter tube designed for service as a combined mixer and oscillator in receivers operating from a low-voltage battery filament supply. Overall height is 4 5/16 ins. See Fig. B, Table III and Fig. 1. A Raytheon tube. Sylvania recently announced the same type number.

1C5G

The 1C5G is a pentode-type power amplifier tube designed for service in the output stage of receivers operating from a low-voltage battery filament supply. Overall height is



Fig. C



Fig. D



Fig. E

NEW TUBES!

which RADIO-CRAFT predicted would soon follow continued insatiable demand for new tubes. Here are some of them.

R. D. WASHBURNE

4 ins. These data are tentative. See Fig. B, Table IV and Fig. 1. A Raytheon tube. Sylvania recently announced it, too.

1H5G

The 1H5G is a diode-triode type amplifier tube designed for service as a combined diode-detector and amplifier in receivers operating from a low-voltage battery filament supply. Overall height is 4 5/16 ins. See Fig. B, Table V and Fig. 2. Data from Raytheon. Also announced by Sylvania.

1N5G

The 1N5G is a pentode-type amplifier tube designed for service as a high-frequency amplifier in receivers operating from a low-voltage battery filament supply. Overall length is 4 5/16 ins. See Fig. B, Table VI and Fig. 2. Data by Raytheon; equivalent data received from Sylvania.

4A6G

The 4A6G is a twin-triode power amplifier tube designed for service as a class B power amplifier in the output stage of battery-operated receivers. The filament mid-tap is connected to base pin No. 8, allowing operation of the filaments in series at 4 volts or in parallel at 2 volts. An output of 1 watt is secured with 90 volts on the plate. Overall height is 4 1/8 ins. See Fig. C, Table VII and Fig. 2. A Raytheon tube.

TELEVISION, ETC.

So much for the new battery tubes. Now let's see what else is new.

1852

The 1852 is a heater-cathode type of metal tube intended for use by the amateur and experimenter in experimental television receivers. It is recommended for use in the R.F. and I.F. stages of

the image amplifier of such receivers as well as in the first stages of the video amplifier when several video stages are employed. The 1852 can also be used as a mixer and makes a good oscillator in low-voltage applications.

The electrode assembly of the 1852 is the same as that in the 1851, but a special shielded lead construction has been employed in the 1852 to permit bringing out the control-grid lead to a base pin rather than to a pin cap. With this construction, it has been possible to keep the grid-plate capacity as low as that of this tube with capped construction. From a circuit standpoint, the proximity of grid pin to cathode pin simplifies wiring and decreases the size of the inductance loop connecting the input circuit to the tube. These are features important at high frequencies because they provide decreased feedback and improved circuit stability. Overall height is 2 5/8 ins. See Fig. D, Table VIII and Fig. 2. An RCA tube.

1853

The 1853 is a heater-cathode type of metal tube intended for use by the amateur and experimenter in experimental television receivers. Because of its extended cut-off characteristic, it is recommended for use in the R.F. and I.F. stages of the image amplifier of such receivers, particularly those employing automatic gain control. The 1853 can also be used as a mixer and makes a good oscillator in low-voltage applications.

A special shielded lead construction has been employed in the 1853 to permit bringing out the control-grid lead to a base pin rather than to a pin cap.

Overall height is 2 5/8 ins. See Fig. E, Table IX and Fig. 3. An RCA tube.

The series-screen-resistor method of obtaining screen-grid voltage from the plate supply is satisfactory for the 1853 because its suppressor practically re-

15 NEW TYPE TUBES

- 1231—Television Video Amplifier (Outstandingly new base design.)
- 1A5G—Low-Power Pentode Output (1.4 V.)
- 1A7G—Pentagrid Converter (1.4 V.)
- 1C5G—High-Power Pentode Output (1.4 V.)
- 1H5G—Diode-Triode (1.4 V.)
- 1N5G—R.F. Pentode Amplifier (1.4 V.)
- 4A6G—Twin-Triode Power Amplifier (Series fil., 4 V.; parallel, 2 V.)
- 1852—Television R.F. and I.F. Pentode Amplifier
- 1853—Television R.F. and I.F. Pentode Amplifier (For use in Automatic Gain Control circuits.)
- 6AD6G—Twin-"Eye" Visual Indicator (Wide-angle type.)
- 6AE6G—Dual-Plate "Eye"-Control Tube
- 6AF6G—Twin-"Eye" Visual Indicator (Medium-angle type.)
- 832—Push-Pull, 2-Meter Beam Power Amplifier
- 1619—Fast-Heating, Filament-type 45-Megacycle Transmitter, Beam Power Amplifier
- HY615—Ultra-H.F. Transmitter Triode (Amplifier, oscillator, detector.)

moves the effects of secondary-emission phenomena. With this method, the screen-to-cathode voltage will rise as the control-grid voltage is varied from minimum to maximum. This rise of screen-to-cathode voltage above the normal maximum value is allowable because the screen-grid and the plate current are reduced simultaneously by a sufficient amount to prevent damage to the tube.

6AD6G

The 6AD6G is a 6.3 V. high-vacuum type indicator tube with 2 independent control electrodes casting shadows on opposite halves of the fluorescent target! The control electrodes may be connected in parallel to produce 2 shadows varying simultaneously or each control electrode may be supplied with a separate controlling voltage. See Fig. F, Table X and Fig. 3; "eye" pattern, Fig. 5.

(Continued on following page)

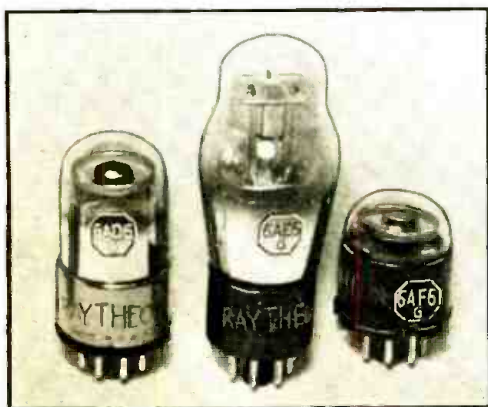

Fig. F

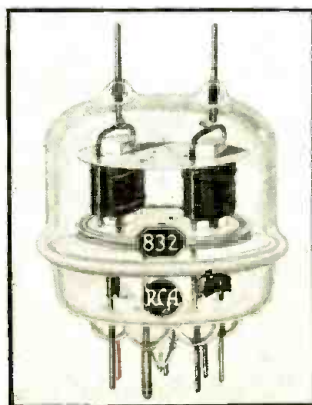

Fig. G

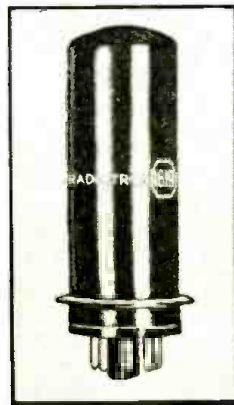

Fig. H

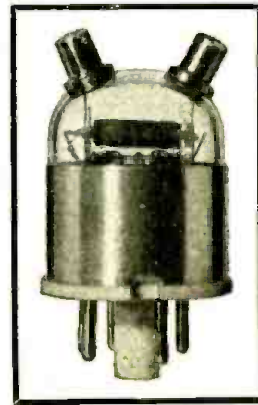

Fig. I

FIFTEEN NEW TUBES!

(Continued from preceding page)

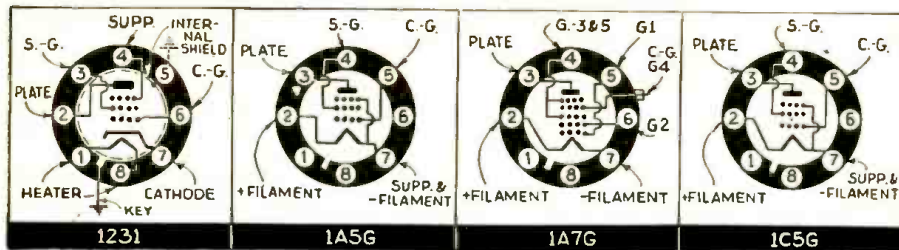

Fig. 1.

A Raytheon tube. National has done considerable pioneering in tubes of this type, and has announced availability of the 6AD6G.

Overall height is 2 9/16 ins. Octal base and "bantam shell." The "eyes" (see Fig. 5) operate independently or together!

6AE6G

The 6AE6G is a special-purpose tube primarily intended for use as a control tube in conjunction with cathode-ray tuning indicator tubes such as the type 6AD6G. Overall height is 2 3/4 ins. Data by Raytheon; this type member has also been announced by National Union. See Fig. F, Table XI and Fig. 3.

6AF6G

The 6AF6G is a high-vacuum type indicator tube with 2 independent control electrodes casting shadows on opposite halves of the fluorescent target. The control electrodes may be connected in parallel to produce 2 shadows varying simultaneously or each control electrode may be supplied with a separate controlling voltage. Overall length is 2 5/16 ins. A Raytheon tube. Also announced last month by RCA. See Fig. F, Table XII and Fig. 3; pattern, Fig. 5.

832

The 832 is a heater-cathode type of transmitting tube containing in one envelope 2 beam power units. The tube is designed primarily for use as a push-pull R.F. power amplifier with maximum ratings at wavelengths as short as 2 meters, and with reduced ratings at wavelengths as short as 1 meter. Its total plate dissipation is 15 watts for class C telegraph service. Neutralization of the tube is unnecessary in adequately shielded circuits.

The exceptional efficiency of the 832 at the ultra-highfrequencies is made possible by the balanced and compact structure of the beam power units, excellent internal shielding, and close electrode spacing. The internal leads are short and heavy in order to minimize internal lead inductance. The terminal arrangement provides excellent insulation, facilitates symmetry of circuit layout.

The heaters are arranged to allow operation from either a 12.6- or a 6.3-volt supply. Height of tube, 3 7/16 ins. See Fig. G, Table XIII and Fig. 4. An RCA tube.

1619

The 1619 is a beam power transmitting tube of the metal type utilizing a coated filament to provide fast heating. The high power sensitivity and the quick-heating feature of this tube make it especially suited for use as an A.F. or R.F. amplifier, modulator, frequency multiplier, or oscillator in equipment where quick off-on operation is essential.

Operation of the 1619 with maximum ratings is practical at frequencies as high as 45 megacycles. Neutralization of the tube

is generally unnecessary in adequately shielded circuits. In push-pull class AB2 amplifier service, the 1619 will deliver over 35 watts of audio power with low distortion. Its maximum plate dissipation is 15 watts. An RCA tube. Overall length, 4 5/16 ins. See Fig. II, Table XIV and Fig. 4.

HY615

Note: Plate and grid leads are brought out to caps in the dome of the bulb. The HY615 features short connection leads, small internal elements and low interelectrode capacities resulting in efficient operation at ultra-highfrequencies. May be used for: ultra-highfrequency oscillator, R.F. amplifier, detector.

Ceramic Base

Overall height is 2 3/16 ins. A Hytron tube. See Fig. I, Table XV, and Fig. 4.

CHARACTERISTICS

1231—TABLE I

Tentative Characteristics			
Heater voltage, A.C. or D.C.	6.3 volts		
Heater current	0.45-ampere		
Direct Interelectrode Capacities			
Grid-to-plate (as pentode)	0.015-mmf., max.		
Grid-to-all other elements	8.5 mmf.		
Plate to all other elements	6.5 mmf.		
Operating Conditions and Characteristics			
	Pentode	Tetrode	Triode
Heater voltage	6.3	6.3	6.3 volts
Heater current	0.45	0.45	0.45-ampere
Plate voltage	300	300	250 volts
Screen-grid voltage	150	150	(to plate) volts
Cathode-bias resistor	200	200	400 ohms
Suppressor-grid (to cathode)	(to screen-grid)	(to plate)	
Plate current	10.0	12.0	13.0 ma.
Screen-grid current	2.0	0.5	— ma.
Plate resistance	700,000	640,000	5,200 ohms, aprx.
Mutual conductance	5,500	6,500	6,300 micromhos
Amplification factor	3,850	3,500	33

1A5G—TABLE II

Ratings		
Filament voltage	1.4 D.C. volts	
Filament current	0.05-amp.	
Max. plate voltage	90 volts	
Max. screen-grid voltage	90 volts	
Amplifier—Class A		
Plate voltage	85 volts	
Screen-grid voltage	85 volts	

Grid bias	-4.5 volts
Transconductance	800 micromhos
Plate current	3.5 ma.
Screen-grid current	0.7 ma.
Load resistance	25,000 ohms
Total harmonic distortion	10 per cent
Power output	100 mw.

1A7G—TABLE III

Ratings	
Filament voltage	1.4 D.C. volts
Filament current	0.05-amp.
Max. plate voltage	90 volts
Max. screen-grid voltage	45 volts
Max. grid (No. 2) voltage	90 volts
Direct Interelectrode Capacities	
G4 to P (control-grid to plate)	0.30* mmf.
G4 to G2 (control-grid to oscillator anode grid)	0.25* mmf.
G4 to G1 (control-grid to oscillator grid)	0.11* mmf.
G1 to G2 (oscillator grid to plate)	1.4* mmf.
G4 to all other electrodes (R.F. input electrode)	6.3 mmf.
G2 to all other electrodes except G1 (oscillator output electrode)	4.1 mmf.
G1 to all other electrodes except G2 (oscillator input electrode)	3.7 mmf.
Plate to all other electrodes (mixer output electrode)	8 mmf.
Frequency Converter	
Plate voltage	90 volts
Screen-grid (grids No. 3 & No. 5) supply voltage	90 volts
Series screen-grid resistor	70,000 ohms
Anode grid (No. 2) voltage	90 volts
Control-grid (No. 4) bias	0 ** volts
Oscillator grid (No. 1) resistor	200,000 ohms
Plate resistance	0.6-megohms
Conversion transconductance	125 micromhos
Plate current	0.6-ma.
Screen-grid current	0.65-ma.
Anode grid current	1.1 ma.
Oscillator grid current	35 microamps.
Total cathode current	2.3 ma.
Conversion transconductance (At control-grid bias = -1.4 volts)	25 micromhos
Conversion transconductance (At control-grid bias = -2 volts)	5 micromhos
*Measured with close-fitting shield.	
**Return to negative filament—pin 7.	

1C5G—TABLE IV

Ratings	
Filament voltage	1.4-D.C. volts
Filament current	0.1-amp.
Max. plate voltage	90 volts
Max. screen-grid voltage	90 volts
Amplifier—Class A	
Plate voltage	83
Screen-grid voltage	83
Grid bias	-7
Amplification factor	165
Plate resistance	0.110-
Transconductance	1500
Plate current	7
Screen current	1.6
Load resistance	9,000
Total harmonic distortion	10
Power output	200

1H5G—TABLE V

Ratings	
Filament voltage	1.4 D.C. volts
Filament current	0.05-amp.
Max. plate voltage	90 volts
Direct Interelectrode Capacities—Triode Section	
G to P (grid to plate)	1.1 mmf.
G to F (input electrode)	0.35-mmf.
P to F (output electrode)	4.0* mmf.

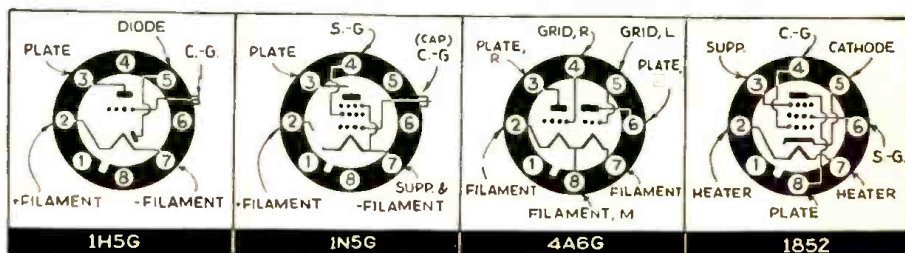

Fig. 2.

Amplifier—Class A—Triode Section

Plate voltage	90 volts
Grid bias	0 ** volts
Plate resistance	0.24-megohm
Transconductance	275 micromhos
Plate current	0.15 ma.

*Diode plate connected to pin 7.
**Return to negative filament—pin 7.

1N5G—TABLE VI
Ratings

Filament voltage	1.4 D. C. volts
Filament current	0.05-amp.
Max. plate voltage	90 volts
Max. screen-grid voltage	90 volts

Direct Interelectrode Capacities

G1 to P (Control-grid to plate) 0.007-max. mmf.
G1 to F, G2 & G3 (input electrode) 2.2 mmf.
P to F, G2 & G3 (output electrode) 9.0 mmf.

Amplifier—Class A

Plate voltage	90 volts
Screen-grid voltage	90 volts
Control-grid bias	0 ** volts
Plate resistance	1.5 megohms
Transconductance	750 micromhos
Plate current	1.2 ma.
Screen-grid current	0.3-ma.
Transconductance (approx.)	50 micromhos

(At control-grid bias = -3.2 volts)
Transconductance (approx.) 5 micromhos
(At control-grid bias = -4.0 volts)
*Measured with close fitting shield.
**Return to negative filament—pin 7.

4A6G—TABLE VII

Ratings		Series Connection	Parallel Connection
Filament voltage		4	2 volts
Filament current	0.06-		0.12-amp.
Max. plate voltage			90 volts
Max. peak plate current (per plate)			25 ma.

Amplifier—Class A—Triodes Connected in Parallel

Plate voltage	90 volts
Grid bias †	-1.5 volts
Amplification factor	20
Plate resistance	13,300 ohms
Transconductance	1,500 micromhos
No-signal plate current	2.2 ma.

Amplifier—Class B

Ideal Conditions (Low grid impedance)		Typical Operating Conditions (Grid regulation)	
Grid-circuit impedance (at 400 cycles)	0	0	2000
Plate supply impedance	0	0	0
No-signal plate voltage	90	90	90
Grid bias †	0	-1.5	0
Effective load resistance (plate-to-plate)	8,000	8,000	8,000
Peak signal per grid	23.2	26.2	22.6
Total power output	1.0	1.0	1.0
No-signal plate current (per plate)	2.3	1.1	2.3
D.C. plate current per plate (at 1.0 watt output)	10.8	10.8	10.8
Peak power input (at 1.0 watt output)	—	—	65
Grid resistance (at peak of A.F. cycle)	—	—	3,900
Total distortion	5.5	5.6	8.5
3rd-harmonic distortion	5	5	8
5th-harmonic distortion	1	1.5	2

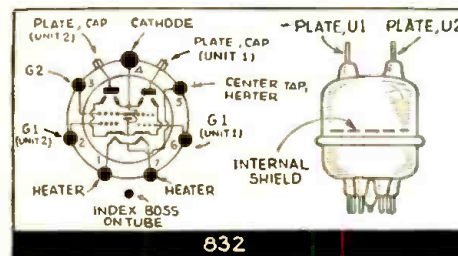

Fig. 4, above.

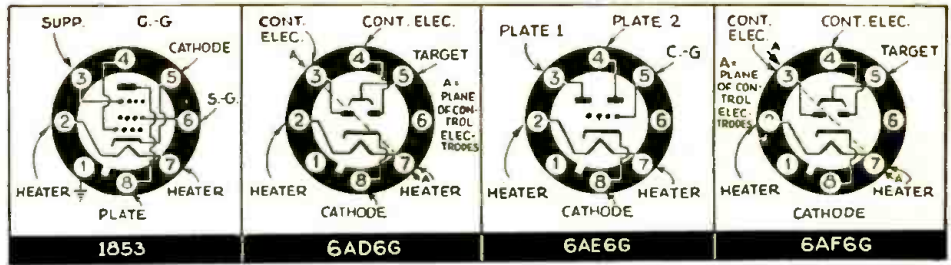

Fig. 3.

† Grid bias measured from negative filament of each section.

1853—TABLE VIII

Tentative Characteristics and Ratings

Heater voltage (A.C. or D.C.)	6.3 volts
Heater current	0.45-ampere
Direct interelectrode capacities:	
Grid-to-plate	0.015-max. mmf.
Input	11 max. mmf.
Output	5 max. mmf.

Maximum Ratings and Typical Operating Conditions

Plate voltage	300 max. volts
Screen-grid voltage	150 max. volts
Screen-grid supply voltage	300 max. volts
Plate & screen-grid dissipation (Total)	3.4 max. watts
Screen-grid dissipation	0.38-max. watt

Typical operation and characteristics:

	Condition I*	Condition II**
Plate voltage	300	300
Suppressor-grid voltage	0	0
Screen-grid supply voltage	150	300
Screen-grid series resistor	—	60,000 ohms
Cathode-bias resistor	160 min.	160 min.
Amplification factor (approx.)	6,750	6,750
Plate resistance (approx.)	0.75-	0.75-megohm
Transconductance	9,000	9,000 micromhos
Plate current	10	10 ma.
Screen-grid current	2.5	2.5 ma.

* With shell connected cathode.
* Condition I with fixed screen-grid supply gives a sharp cut-off characteristic.
** Condition II with series screen-grid resistor gives an extended cut-off characteristic for applications where gain is controlled by variation of grid bias.

†† The D.C. resistance of the grid circuit should not exceed 0.25-megohm when the screen-grid voltage is obtained from a fixed source. When a series screen-grid resistor is used with full cathode bias, the D.C. resistance in the grid circuit may be made as high as 0.5-megohm.
‡ Screen-grid supply voltages in excess of 150 volts require use of a series dropping resistor to limit the voltage at the screen-grid to 150 volts when the plate current is at its normal value of 10 ma.

1853—TABLE IX

Tentative Characteristics and Ratings

Heater voltage (A.C. or D.C.)	6.3 volts
Heater current	0.45-ampere
Direct interelectrode capacities:	
Grid-to-Plate	0.015-max. mmf.
Input	8 mmf.
Output	5 mmf.

Maximum Ratings and Typical Operating Conditions

Plate voltage	300 max. volts
Screen-grid voltage	200 max. volts
Screen-grid supply voltage	300 max. volts
Plate and screen-grid dissipation (total) (Ratings must not be exceeded.)	4.4 max. watts
Screen-grid dissipation	0.65-max. watts

Typical operation and characteristics:

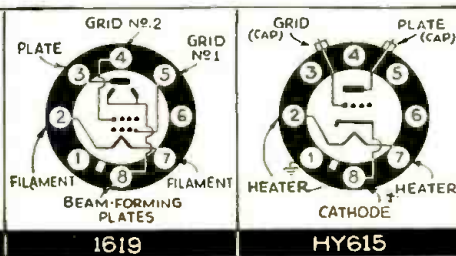

Fig. 5, right.

	Condition I*	Condition II**
Plate voltage	300	300 volts
Suppressor-grid voltage	0	0 volts
Screen-grid supply voltage	200	300 volts
Screen-grid series resistor	—	30,000 ohms
Grid voltage	-3 min.	-3 min. volts
Amplification factor (approx.)	3,500	3,500
Plate resistance (approx.)	0.7-	0.7-megohm
Trans-conductance	5,000	5,000 micromhos
Grid bias for transconductance = 50 micromhos	-15	-22.5 volts
Plate current	12.5	12.5 ma.
Screen-grid current	3.2	3.2 ma.

• With shell connected to cathode.
* Condition I is with fixed screen-grid supply.
** Condition II is with series screen-grid resistor.
‡ Screen-grid supply voltages in excess of 200 V. require use of a series dropping resistor to limit the voltage of the screen-grid to 200 V. when the plate current is at its normal value of 12.5 ma.
• May be obtained with cathode-bias resistor having a minimum value of 190 ohms.
†† The D.C. resistance of the grid circuit should not exceed 0.25-megohm with fixed bias. When the full cathode bias and a series screen-grid resistor are used, the D.C. resistance of the grid circuit may be as high as 0.5-meg.

6AD6G—TABLE X

Ratings

Heater voltage (A.C. or D.C.)	6.3 volts
Heater current	0.15-amp.
Max. target voltage	150 volts

Tuning Indicator

Target voltage	100	150 volts
Control electrode voltage (approx.) (For shadow angle = 0°)	45	75 volts
Control electrode voltage (approx.) (For shadow angle = 90°)	0	8 volts
Control electrode voltage (approx.) (For shadow angle = 135°)	-23	-50 volts
Target current - 0° shadow (approx.)	1.5	3.0 ma.
Target current - 90° shadow (approx.)	1.0	2.0 ma.
Target current - 135° shadow (approx.)	0.8-	1.2 ma.

6AE6G—TABLE XI

Ratings

Heater voltage (A.C. or D.C.)	6.3 volts
Heater current	0.15-amp.
Max. plate voltage	250 volts

Plate No. 1 (Remote Cutoff)

Plate voltage	250	250	250	250
Grid bias	-35	-15	-6	-1.5
Plate current	0.01-	0.8-	2.8	6.5 ma.

(Continued on page 311)

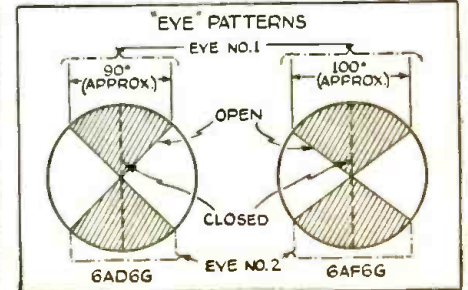

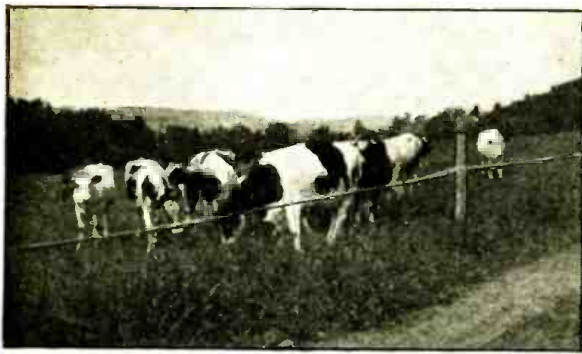

Fig. A. One-wire fence, electrically charged, replaces expensive picket fence for cattle.

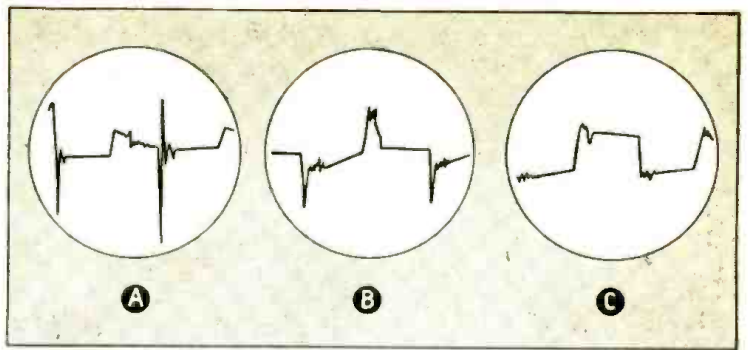

Fig. 2. Oscillograms showing condition of voltage in the fence under various conditions of load.

LATEST SIDELINE FOR SERVICEMEN ELECTRIC FENCE UNIT

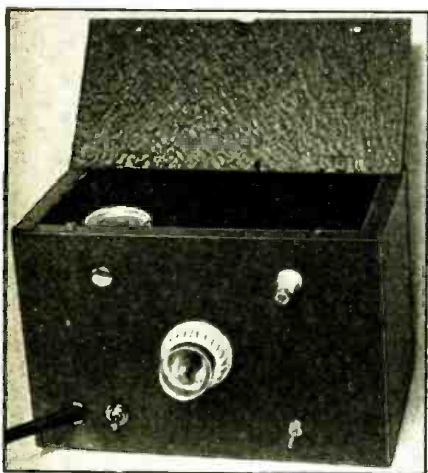

Fig. B. This is the simple unit which supplies voltage to the single-wire fence.

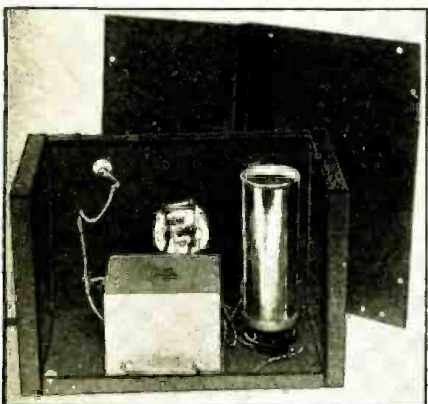

Fig. C. Rear view of the electric-fence unit showing the vibrator, transformer, neon-lamp socket and switch.

According to the author, millions of farmers constitute a virgin field for the sale and installation of a simple and inexpensive electrified livestock fence. It has other uses.

M. N. BEITMAN

THE Electric Fence has found a ready place on the farm and presents opportunities for the aggressive radio Serviceman to enter this field, selling, building, and repairing this equipment. *A single wire charged with electricity (see Fig. A) is more effective in keeping livestock in selected fields and keeping intruders out, than the old-fashioned barbed wire or board fence.*

Naturally, the expense of a single wire fence placed on light stakes up to 50 ft. apart will be but a fraction of the corresponding old-style fence. Only 200,000 farmers are now using electric fence equipment and there are actually millions of farmers waiting to be sold this new improvement.

The use of electric fence equipment is not limited to the farm, many applications can be found in the city and at home. For example, you can use an electric fence to keep dogs out of your yard or perhaps you will want to use an electric shock to keep thieves away from your automobile.

USES 6 VOLTS

Of course, many different types of fence controls operating on various principles have been placed on the market. However, the demand seems to be

primarily for a 6-volt operated unit of the simpler type that can be marketed at a reasonable figure. The circuit of the control illustrated (in Figs. B and C) incorporates the essential features required and uses but a few inexpensive ordinary radio parts. The vibrator (see Figs. 1A and B) serves to interrupt the D.C. source of power and the transformer produces a higher voltage on the secondary. This voltage in turn is applied to the fence and ground, and any individual coming in contact with the electric fence while standing on the ground will receive a shock. A neon bulb indicates this leakage to ground.

The actual turns ratio of the transformer produces about 150 volts on the secondary and this is barely enough to give a shock. However, the presence of transient current helps in this regard and places under no-load condition voltages as high as 1,400 volts on the fence. This voltage, however, is safe under all conditions for it is reduced immediately to a safe value when a shorted condition or a partial load is placed on the fence control unit.

The reader should now refer to the oscilloscope diagrams shown in Fig. 2. These diagrams show the condition of voltage under various load conditions as follows:

(Continued on page 301)

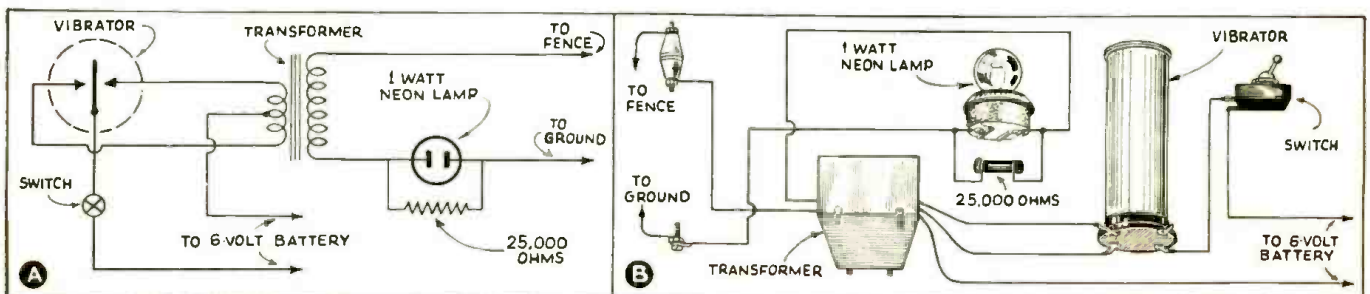

Fig. 1. Schematic diagram (A) of the electric fence control, 6-volt model, using vibrator. The pictorial diagram is shown in B.

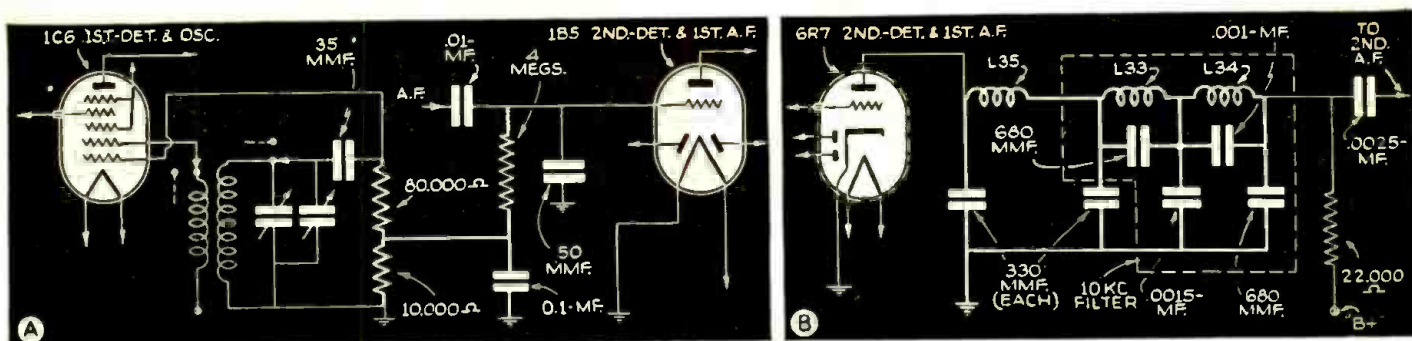

Fig. 1. New circuit features in Wells-Gardner and Silvertone receivers. The heavy lines accentuate the points discussed in the text.

NEW CIRCUITS IN MODERN RADIO RECEIVERS

The details of the modern radio receiver circuits that make them "different" from previous designs are illustrated and described each month by a well-known technician.

F. L. SPRAYBERRY

NUMBER 14

(1) 1st A.F. BIAS DERIVED FROM OSCILLATOR GRID LEAK

Wells-Gardner & Co., Model 5H Series, Auto Radio. A very ingenious method of solving part of the bias problem is used in these receivers, which allows no loss of the power supply efficiency.

The voltages induced in the grid circuit of an oscillator are at first impressed on a grid with no bias (most usual) and each time the grid becomes positive, it draws current. This current flowing through the grid leak produces a negative bias at the grid.

Now as shown in Fig. 1A, the grid leak takes the form of a voltage divider so that a negative voltage in proportion to the resistance to ground can be tapped off for use as the 1st A.F. bias. The bias for the 1B5 1st audio amplifier is only 1/9th of that developed at the oscillator grid, so the grid leak is tapped at a point providing 1/9th of the resistance from ground to grid. The R.F. is completely filtered out of the bias circuit of the 1B5 by means of the 0.1-mf. and 50 mmf. condensers and the 4 meg. grid leak. This solves an otherwise difficult bias problem as filament-type tubes are used.

(2) IMPEDANCE COUPLING USED IN T.R.F. SET WITH FILLED-CORE TUNING COILS

Silvertone Chassis 101, 526. This high-fidelity receiver used primarily for local station reception makes use of impedance coupling of the 2nd R.F. stage and detector, using medium-permeability filling for the cores of its tuning coils.

Disclosed as in Fig. 1B, it will be noted that a pie-type, air-core choke coil is used in the 1st and 2nd R.F. plate circuits for plate loading. The R.F. signal voltage developed at the plate with respect to ground by reason of this loading is induced into successive grid circuits through coupling condensers of exceedingly small capacity (15 mmf.). The total A.C. plate load impedance is quite high, permitting a good voltage gain. The selectivity is reasonably good per stage, while the total selectivity is fairly low, as there are only 2 stages used. Such a circuit is ideally adapted for local-station high-fidelity reception.

(3) SERIES BIAS CELLS USED IN A.V.C. FEEDER

Silvertone Models 4640, 4650, 4740 and 470. Use of bias cells in circuits having 2 volt, filament-type tubes great-

ly simplifies wiring and testing, to say nothing of design problems.

Fig. 2A shows a conventional half-wave, rectifier-type 2nd-detector, furnishing A.F. and A.V.C. potentials. Immediately beyond the 2 meg. A.V.C. filter a double section bias cell is added so as to maintain approximately minus 3 volts minimum bias on the controlled tubes.

(4) EFFECTIVE 10 KC. FILTER USED

RCA Models HF-6, HF-8, U-132, U-134. To take advantage of the full fidelity range of which these receivers are capable above the 10 kc. range, a sharply tuned band elimination filter is used.

This filter as shown in Fig. 2B consists of several tuned sections to present a very high resistance to frequencies of 10 kc. This is necessary because any 2 broadcast stations on adjacent channels will produce a 10 kc. heterodyne. When the receiver is tuned broadly enough to permit frequencies in excess of 10 kc. either side of the carrier to be received, adjacent-channel station carriers are also likely to be received.

(Continued on page 304)

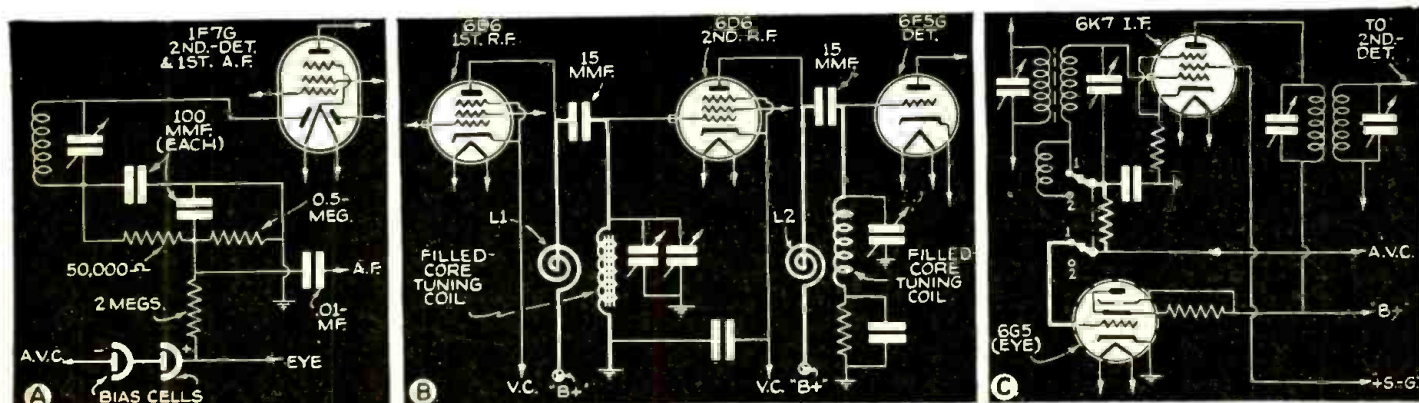

Fig. 2. Silvertone, RCA-Victor and Emerson circuit features. The heavy lines accentuate the points discussed in the text.

THE LATEST RADIO EQUIPMENT

Manufacturers are invited to utilize these columns to bring improvements and new devices to the attention of technicians interested in every phase of Radio, Electronics and Public Address.



These condensers bounce! (1685)

PAPER CONDENSERS MOLDED IN LIVE RUBBER (1685)

(Aerovox Corp.)

THE INSULATION resistance and voltage breakdown characteristics of this new line of live-rubber-encased condensers are claimed to be superior to the usual paper condensers. Low-temperature vulcanizing prevents condenser section absorbing moisture; low-pressure process safeguards the paper dielectric. Laboratory tests have indicated a life several times greater than the older types. Available in capacities up to 0.25-mf., 200 V.; 0.1-mf., 400 V.; 0.05-mf., 600 V. and 0.01-mf., 1,000 V.

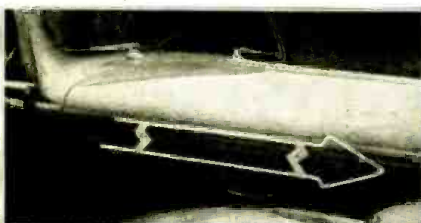

Antennas for car-hood. (1686)

DOUBLE HOOD AUTO ANTENNA (1686)

(Beldorf Electric Mfg. Co.)

THE MAIN purpose for this easily-installed antenna is to eliminate projections on the roof which detract from the appearance of the modern automobile. A kit consists of 2 antennas mounted one on each side of the motor hood. Ground noises, static electricity and the nuisance of snapped leads are claimed to be eliminated. All leads are shielded to within 1/16-in. to the antenna proper. Constructed entirely of brass and triple-chrome-plated it will neither rust nor corrode and is not affected by weather or climatic conditions. No interference is encountered in raising or lowering the hood.

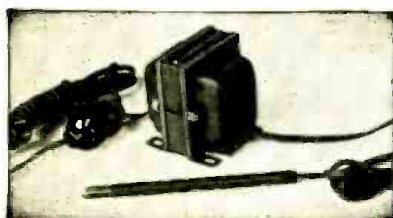

Contact-type carbon "iron". (1687)

THERMO-GRIP SOLDERING "IRON" (1687)

(Ideal Commutator Dresser Co.)

DESIGNED especially for light-duty work in radio sets, telephones, small motors, instruments, etc., this soldering tool constitutes an exceptionally useful adjunct to the Serviceman's tool kit; space does not permit mentioning all its good points. The tool consists of handle with 2 heating carbons, one fixed, the other movable against a spring; and, a step-down transformer. When both carbons contact metal an electric circuit is closed and the metal reaches soldering temperature almost instantly. Tremendous heat is thereby concentrated in the small area to be soldered. This eliminates waste both in radiation and in current while the usual iron is idling. It is especially useful for soldering on large metal surfaces such as radio chassis where intense heat is



A 6-in-1 meter, 9 in. dia.! (1688)

required. Operates only on 110 V., A.C.; draws 100 watts—but only in actual use.

UNIVERSAL TESTER USES 9-IN. METER! (1688)

(The Hickok Electrical Instrument Co.)

A NEW giant "6-in-1" volt-ohm-milliammeter incorporating ranges extended to cover practically all applications of electrical measurements. Its main feature is the large meter with over 7-in. scale which is easily read at any angle and at considerable distance; meter sensitivity is 350 microamperes!

Its wide range of coverage—embracing the requirements of practically every branch of radio!—is as follows: A.C. and D.C. volts, 0 10 50 250/500/2,500; D.C. microamperes, 0.500; D.C. milliamperes, 0/5 50/500; resistance, 0.30 (8 ohms mid-scale) and 0/10,000 (150 ohms mid-scale) ohms, and 0.1 megohm (15,000 ohms mid-scale); and 0/10 megohms (0.15-meg. mid-scale); decibels, -10. +15. Built-in condenser permits use as an output meter. All ranges have an accuracy within 2 per cent.

Shunts are available to give ranges of 5 and 50 A., D.C., for testing car-radio sets, farm battery sets, and D.C. farm lighting plants.

THERMOSTATIC-CONTROLLED SOLDERING IRON STAND (1689)

(Electric Soldering Iron Co., Inc.)

THIS new device cuts the soldering iron in and out of the circuit at any selected temperature, depending upon how hot the iron should be for the particular work involved. The device is said to be highly efficient, saves much of the operator's time, prolongs the life of the soldering tip (and tinning) and of the iron element and, most important, effects a real saving in the use of electric current. The new stand insures a constant, uniform temperature of soldering heat. Full heat is developed in iron when it's removed from stand. (Manufacturer claims this heat-control method superior to using 'stat built into iron.)

PRES-TO OILER (1690)

(The Dill Mfg. Co.)

AS POINTED out in a recent issue of *Radio-Craft*, an oil can is nearly as important a Serviceman's tool as a soldering

(Continued on page 305)

The address of any manufacturer will be sent on receipt of self-addressed, stamped envelope. Kindly give (number) in above description of device.

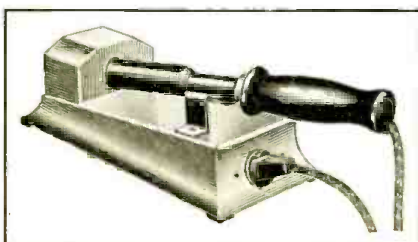

"Why waste time re-tinning," asks ESICO "when a thermostat will keep the soldering-iron's heat even?" (1689)



Job oil where & when wanted! (1690)

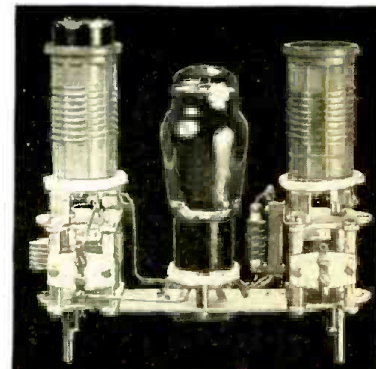

New pre-assembled ham-radio unit. (1691)

All the worthwhile
Radio Trade News
of the past Month—
Digested for busy
radio men.

RADIO Trade Digest

A PLEDGE: — To
give the important
news of the radio
industry; to review
major news; to help
point a path to new
radio profits.

IMPORTANT HAPPENINGS OF THE MONTH IN THE RADIO INDUSTRY

No. 3

NOVEMBER, 1938

No. 3

BUILDING FOR A BOOM— IS TELLY THE ANSWER?

*Television Will Boom Radio,
Say RTD Questionees—
And Tell How!*

Again the replies to the RTD Questionnaires were filled with surprises for the statisticians. Is advance publicity on television hurting the radio biz? What should a receiver cost? How big a television picture is the minimum necessary? (What do you think?)

Now see what the industry in general believes:—

One question dealt with the effect of advance television publicity on the trade in general. Is it helping or harming business?

Nearly half of the significant replies (45.6%) said it was retarding sales,
(Continued on page 308)

INSIDE ON EXPORT

A London radio & tele shop reports biz "pretty bad" on auto-radios at list, but "waking up" & moving in cut-rate market; home radios "dead" 'til after annual exhibition; service biz "fairly steady, but customers won't pay a decent price on account of cheap decontrolled (?) sets now being released by bankrupt mfrs."; P-A "fairly good"—pays best making up foolproof 10-20-w. jobs in trailers, for customer to operate.

SECRET OF PHILCO MYSTERY CONTROL EXPOSED: KADETTE PLANS TO COMPETE

FCC Still to Test Remote Box's 80-Meter I.C.W. Xmtr For Interference, While Dealers Sell Units to Palpitating Public

The "mystery" of Philco's Mystery Control has been solved! It is a mighty clever device, and performs well; its heart is a miniature 80-meter I.C.W. xmtr—the interruptions being made by a telephone-type

dial that automatically turns on the "30" tube which the sealed box contains. Also housed in the box are the necessary "A-B-C" battery (a single unit), and the circuit components for the oscillator.

According to R. Bigonzi, of the East Orange Radio Co., motion of the dial on the PMC immediately turns on the oscillator, the wave from which is picked up by a special circuit in the Philco receiver. Moving the dial breaks the oscillation, the resulting impulse actuating one or more relays which control the tuning motor in the set.

Turns "Off" But Not "On"

The volume control is similarly operated; dialing "Loud" actuates one relay, dialing "Soft", another. The motor drive on the volume control continues to operate as long as the finger stop on the dial is depressed. If held down long enough after dialing "Soft", the set is turned off by remote control. There is no provision for switching the set "On" by remote, as this would entail keeping some of the receiving tubes permanently lit.

New Mystery Adapter Announced

Immediately after Philco hit the market, Kadette announced similar remotely-tuned sets and—more important—a "wireless" remote control box applicable
(Continued on page 308)



"This guy said he'd paid half—so we compromised!"

U. S. GETS 10 NEW FREQS.

Among the new frequencies made available to U. S. bestrs. under the Cairo Convention are 6.170, 6.190, 9.650, 9.670, 17.830, 21.570, 21.590, 21.610, 21.630 and 21.650 mc. For the time being, at least, these will be allocated exclusively for "International Broadcasting."

WHERE DO RADIO SETS SELL?

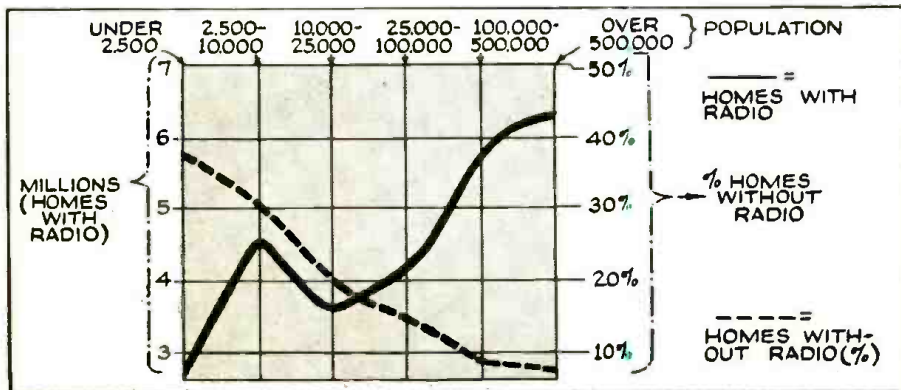

Joint Committee of Radio Research found that larger cities have greater percentage of radio ownership than do hamlets. Heavy line shows about 6 1/4 million sets in cities of over 500,000; only about 2 3/4 million in cities under 2,500. Dotted line shows 36% of smallest-town homes lack radio, while only 7 1/2% of homes in metropoli are radioless. You know where the market is. Go to it!

FARM SET SALES AID Nat. Farm & Home Hr.

Adds 5 Regional Shows

Regional programs in each of the 5 U.S. major zones will have "great practical value for farm audiences." These will feature important local info, as weather, shipping advice, commodity prices & sectional crop conditions.

Goodyear Tire & Rubber Co. will bear cost in 3 zones, NBC in other 2. Program will follow regular N. F. & H. Hr. for 15 min., Mon. through Fri., beginning late in Sept.

Complete regional offices to gather, prepare & distribute the data for local needs are being set up, at press time.

MARKET FOR SPEAKERS IN ENTERTAINMENT

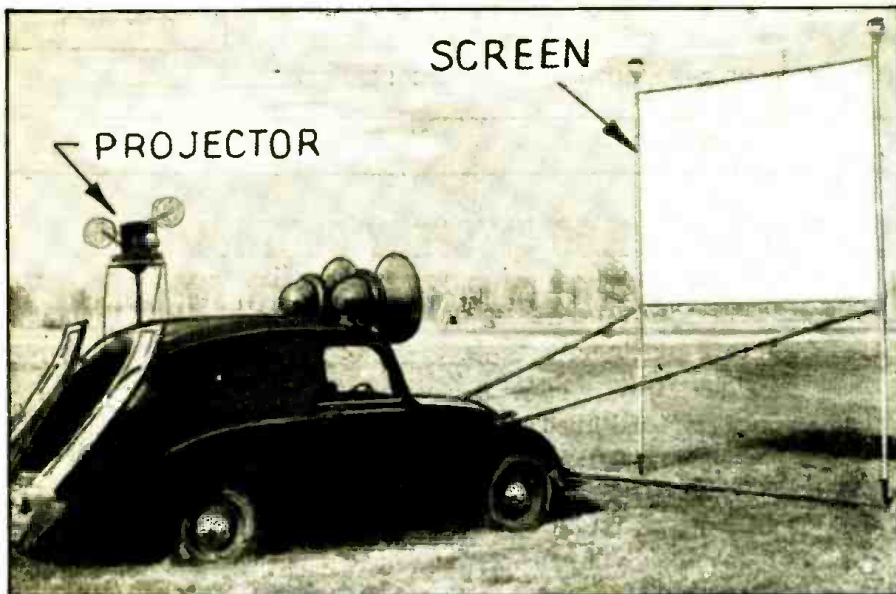

No matter what your politics are, you have to hand it to the Italians—not only Marconi, but the genius who thought of this stunt, too. Ingredients are a truck, a talkie projector, 4 speakers & a translux-type screen. Results: a portable movie theater—& profits. Main cost of job is truck—and you have that.

LAUGHS OF THE MONTH

PIGS IS PIGS

B. A. Yallick writes to announce opening of Academy Bookstore, "7 soors east of Avenue Rd." on Bloor St., Toronto.

If you've read Kipling, you know what a "soor" is; Simmons shot a man for calling him one.

YOOHOO, LOUIS!

Louis, of Cub Radio Service, post-cards, saying:—"I heard some fellow Radio Servicemen talking about Radio Trade Digest & I've been wondering what it is as I've never heard of it, & I thought I'd write you & find out if you knew anything about what it is. If so, will you tell me?"

ANS. This is it, Louis.

RED HOT STATIC

When Servicemen took apart the 2-way set on the Portland, Ore., harbor patrol boat *Mulkey*, to find out what caused a buzzing noise, they found out, all right.

It was a nest of hornets!

PERSONALS

Geo. D. Barbey, 434 Walnut St., Reading, Pa., is organizing sec'y of the new Natl. Radio Parts Distributors' Assn., now being formed. Contact him for data.

After 39 years, Henry C. Glaze, G-E's Rocky Mt. District Mgr., Industrial Division, retired on pension. F. H. Dorenius has taken his place.

Eugene W. Ritter replaces the late J. C. Warner as Gen. Mgr. of RCA's Harrison, N. J., plant. And his former job (Mgr. of Research & Eng. Mgr. of the tube end) is being filled by D. F. Schmit.

Hugh S. Knowles, C.E. of Jensen Mfg. Co., conferred on Theater Standardization in H'wood; attended the IRE convention in Portland, Ore.

Sherman D. Gregory, asst. mgr. of bestg. for Westinghouse, has been made mgr. of KDKA, Pittsburgh, succeeding A. E. Nelson, promoted to sales mgr. of the NBC-Blue net.

(Continued on page 308)

JAP-CHINO WAR TURNS OUT TO BE A COMMERCIAL FLOP

Back in U.S. for week's visit, Walter D. Barker, of Shanghai, Philco's Far Eastern Sales Mgr., said Chinese may become Jap's subjects, but not their customers.

Japan, according to Barker, produces 5-tube copies of U.S. sets to sell as low as \$5. These sets soon become junk, so customer turns to foreign products "with a strong & usually permanent prejudice against Japanese goods."

"Thus," he continues, "the Japanese are really making new customers in the Far East—for Western business."



By this time, Elliott Roosevelt's Texas State Net should be part of the Mutual web And a platter web, run by World Broadcasting System should be in work—making small fry stations harder for vocal novices to crack D. W. Onan & Sons, Minneapolis, Minn., are out with new 2,000 & 3,000 watt generator plants, powered by water-cooled 2-cylinder, 4-cycle gas engines.

Something Wrong Here! American Commercial Attaché at Hague reports (via RMA) Philips of Netherlands as purchaser of U. S. Patent No. 18770, issued in 1928, covering variable condensers with attached trimmers & slotted end plates. But Patent No. 18770 was issued in 1857—just a little before most of us were worrying about radio!

Extra \$\$ from selling room-coolers? Johnson Motors of Waukegan, Ill., has home & office size at \$169.50 list Philco's out with room-coolers, too FTC clamped down on Tune-A-Tube Co. for over-optimistic advs. . . . Bob Livingood's biphonic reproducers are going to be jobbered; a story in this mag aroused so much interest that he's starting a business Seven new CBS spots are rural entertainment; might help farm market?

Pratt Inst. of Bkbn. offers 90 new nite courses, including Air Condi-

tioning, Elements of (& Industrial) Electronics, & Communication systems The INRA (Indy stat. with net tieups) voted to stay a section of the NAB MIT got FCC okay for a new hi-freq. station to be built in a balloon Al Ghirardi's new world-time indicator retails at half a buck; good give-away item, he says. . . .

(Continued on page 308)

WORLD TIME TELLER

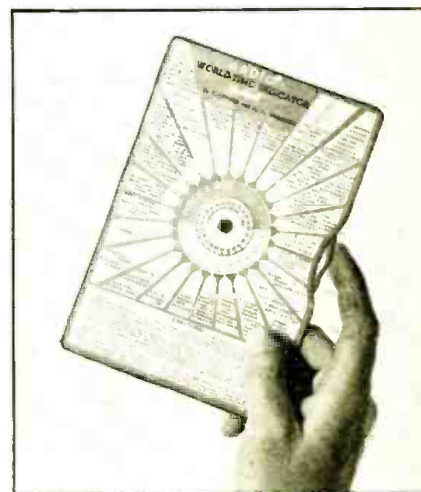

A simple flick of the thumb brings right city in line under known hour. Then all other cities are read against scale, to show their local time. Ghirardi, inventor, suggests it as a give-away or premium or customer puller-inner.

AN EDITORIAL

By Artie Dee

The house organ of a large Western dealer is running a "tall story" contest. One of the entries—not a winner—impressed me very strongly.

The writer said, "A long time ago, I was shipwrecked on a South Sea Island. It was real desert—there was no vegetation or anything else to eat on it. After a few days I was starving, but when I was almost dead,

I found a certain radio *Baloney* catalog in my pocket and *Booklet* started to look through it. In it I found so much baloney that I had actually put on weight by the time I was rescued."

Is this true of *your* catalog or *your* advertising? While the writer of the foregoing was only kidding the company that ran the contest, there is a terrifying truth about his entry.

Many catalogs and many ads are crowded with enough baloney to feed an army for 50 years. This may catch some quick cash from the saps, but sooner or later the Chamber of Commerce, the Better Business Bureau or the Federal Trade Commission steps into the picture. Such entry is seldom pleasant or profitable for the cataloger or advertiser.

Poppa Spank You are probably not an offender — they're in the great minority. But the offenders do cut into the profits of truthful business men. It is to your advantage to help stop this practice.

Associations of Radio Manufacturers exist. It should be the business of such associations to take charge of cleaning house. Take it up with your association—*today!*

WINNERS IN RCA MODERNIZATION CONTEST

Winners in the RCA Modernization Contest, conducted among radio Servicemen & dealers by Radiotron Division of RCA Manufacturing Company, have been announced. More than 600 contestants wrote letters describing methods they had used to modernize radio sets by replacement of "G"-type glass tubes with metal tubes.

Gene N. Henderson, 4544 University Way, Seattle, Wash., 1st prize. (5 RCA service test instruments of his own selection & all RCA bench tools; value, \$250.)

Gibson Brindley, 1101 Hamilton Ave., Trenton, N. J., 2nd prize. (Home Study

SOUND SYSTEM FOR 20 SCHOOL ROOMS

Operadio system TES will work in schools of 20 rooms or less. Outfit includes master control, unit amplifiers, 10 speakers with cabinets, mike & stand. Not included is phone at left, which may be used for calling up blonde.



Sales Helps & Deals

Wise dealers will use them; wise mfrs. will emulate them.

Trade papers, direct mail & point of sale displays will push the test instrument line put out by *Radio City Products Co.*, 88 Park Place, N.Y.C. The co. will send literature on request.

\$110.95 worth of apparatus for \$99.95 is the new *RCA* deal for the public. "Package" includes 7-tube, 3-band 97KG console, record player, records, subscription to *Victor Record Review* & membership in *Victor Record Society*. Natl. newspaper ads in key markets, plus dealer & wholesaler ads in local papers will push the offer. Active dealers will get free direct mail aid, & customers taking demonstration

will get free map of world's entertainment.

Added to *Arcturus* equipment deal are *Weston*, *Precision* & *Supreme* test equipment, new p-b testers, Standard Cash & Change register, & dealer's neon sign.

Contest with 12 awards totaling \$500 seeks data on unusual applications of standard instruments & control devices, closes Nov. 15. Get data from *Instrumentation Contest*, 1115 Wolfendale St., Pittsburgh, Penna.

Good promotion stunt of release of disc by *Boston Symphony* under Serge Koussevitzky; timed to hit market when same selection "Lieut. Kiji", was being played by Prof. K of the Symph at the Stockbridge, Mass., Berkshire Music Festival?

A 4-pp. folder describes a number of Philco sales helps, ranging from match books & duplicators to shop coats & decalcomanias. Also included is folder offering test equip't at dealer rates.

Fada Pulls a Promotion

Brightest stunt of the month is the Fada promotion in conjunction with the N.Y. State Fair in late Aug. & early Sept. Prizes to winners in Fair's dance contest (under Arthur Murray supervision) are 50 small Fadas; total value, \$1,000; publicity value, infinite. Fair's placards in dance halls, newspaper ads, best ads & publicity all mention line by name.

Live promotion man, there.

CHANGES IN ADDRESSES

THE CALCATERRA SERVICE moved to Millington, N. J., where Jos. Calcaterra continues his publicity, catalog & editorial work.

UNIVERSITY LABS moved factory and sales offices to 195 Christie St., N.Y.C. Mfrs. of internally-folded air column trumpets & p.m. dynamic driver units for P.A. work.

BELL SOUND SYSTEMS, INC., moved factory & gen. offices to 1183 Essex Ave., Columbus, O. Mfrs. of P.A. systems & intercommunicators, etc.

TILTON ELECTRIC CO., 20 East 36th St., N.Y.C., now exclusive distributors of Transducer Corp. of America's "Bullet Type" mikes.

AUDIO DEVELOPMENT CO., moved factory to 123 Bryant Avenue North, Minneapolis, Minn. Mfrs. of sound, radio & television equip't.

TELEVISION ACTIVITY INCREASES

New Co. Formed — Remote Viewer — Course Offered — Zworykin Improvement — Month of Broadcasts

Healthy signs in any business are rush of outsiders to become insiders, formation of new cos.

One such new co. is Television Sales & Service Corp., which plans to handle telly bestg & receiving equipt.

Directors are Attorney Jas. Bennett, Thos. V. Malley & Max Gilbert.

Stock issue is only 1,000 shares, so this looks more like a real business than a promotion.

Kinet a Remote Video Unit

One apparently practical idea made its appearance last month—the Kinet, of American Television Corp. This is a separate unit 10 x 10 x 34 in., containing a 5-in. C-R tube & power pack. It is operable at a point remote from the set. Intended to be sold as part of one ATC console, it might be adapted to give video in every room from a single receiver. Image, viewed via mirror & lens, appears 6 x 7½ in.

Whether unit is patented or even patentable is unknown, as co. ignores requests for patent information insofar as it relates to television.

Press agent E. F. Nathenson asserts line now has 4 models, priced from \$125-\$395 & guaranteed against obsolescence for yr. He avers that all stores which demonstrated ATC sets will handle them in Fall or Winter, except

Wanamaker, & Abraham & Strauss, which are off the NBC xmtr beam. He says stock sale is going good, with many biggies buying. Co. is inc. for 1,000,000 shares.

N. Y. Television Tests

RCA television xmtr opened in late Aug. for series of field tests. Lest any optimistic reader get overenthusiastic, engineers announced that they did not contemplate running station for more than mo. before shutting down to do further experimental work.

Television Course Started

RCA Institute, of N.Y.C., recognizes either the imminence of television or that the general interest in it has made courses salable. At all events, the Inst. has announced a course in telly, for fall semester. Price, \$870, payable weekly.

Novices will have to take 2 yrs. in day school or 5 in night school; studes with radio training can take shorter course.

(Continued on page 308)

OFF THE PRESS

CAT. SHEET 28A. Nash Radio Products Co., 5437 Lisette Ave., St. Louis, Mo. Describes new product, "Record-Lube," to relieve surface tension on records & reduce scratch noise. Pkgs., 2 oz., 8 oz., & gal. One application said to be okay for 50 playings. Sheet on request from mfr.

WHAT'S NEW. 8 pp. Western Adv. Agency, 35 E. Wacker Drive, Chicago, Ill. Promotional & educational data on new items in clients' lines, together with news, diagrams & pictures. Sent free if request is written on business letter-head.

1938 WARRANTY LABOR SERVICE HANDBOOK. 16 pp. Transitone Automobile Radio Corp., Phila., Pa. Defines terms, outlines policy, gives codes, instructions & tips.

(Continued on page 310)

GOVERNMENT IN RADIO

Many words have been spilt about Gov't entry into radio. Conservatives, with bated breath, have awaited opening of Fed. sta. in Washington, to supply programs to networks; of rumored s-w stas. supplying info to S. Amer. Conservatives tremble lest these propagandize too much; liberals lest they do so insufficiently.

Few, outside of bestg. biz, realize gov't is now heavily in radio. WPA shows are

BIZ OPPTS

There's business for those who will take the trouble to go after it. Here are 2 chances. Are they in your line?

From England comes this request:—"I want to get in touch with an exporter who can send me about a dozen or so second-hand car-radios at the lowest price possible, as I have a good prospective cash market for them."

If any RTD reader wants to contact this shop, address Box AA5, c/o Radio-Craft.

Also English:—"We are interested in purchasing radio & electrical surplus goods of all descriptions, & would be pleased if you can put us in contact with any firms who have any for disposal."

If any RTD reader wants to contact this shop, address Box AA6, c/o Radio-Craft.

\$'s & N^o's

BIZ BOOMING?: First increase in radio biz since Nov., '37 was shown by Fed. radio excise tax in June, '38—up 12% over June, '37, to \$448,882.61. Upturn in offing, though 1st ½ of '38 was 31.5% below '37 period by same figs. For yr. ending 6/30/38, drop was 13.4% from '37, tax receipts showed. This was million below Treasury estimates, made when continuation of tax was considered. Collections in July were 29.6% below preceding year, however, and 32% below preceding month.

EXPORTS DOWN:—Govt. reports show radio export biz down 14.5% for year ending June 30, as compared with '37—though that year was all-time high. (It beat '36 by almost \$1,000,000.) The '37-'38 fig. was \$27,062,445. Xmtrs. were up 32.8%; receivers down 23.1% in no. & 22.8% in value; tubes down 19.5% in no. & 19.3% in value.

RURAL RADIO:—A Philco-made survey of over 200,000 electrified farms showed 93.7% have radios. Of these, 12.1% were under 1 yr. old; 1-2 yrs., 31%; 3-5 yrs., 25.1%; over 6 yrs.

(Continued on page 310)

MONTHLY BIO



SAM M. HARPER

After graduation from Carnegie Tech, Sam saw service in France, as a Sgt. of the Signal Corps; was also at Camp Vail, N. J. Out of the Army, he became line foreman for Metro Electric in Chi., then took charge of final tests for Majestic, later switching to Asst. Supt. of Household Utilities. In '32, he joined Clough-Brengle as Chi. Rep., coming to N.Y. for same co. in '36 as Eastern Rep. He's Turner Mike rep., too. Just back from Pennsy tour, Sam reports jobber optimism high for post-Labor Day boom, based on present upturn (best biz in 60 days). Lots of interest in test equip't, with better grade mdse. leading. At least Sam says so.

"SIGNAL-TEST" System of TROUBLE-SHOOTING

A system of testing and suitable test equipment have been evolved to permit checking receiver performance with the incoming signal as the basis.

PART II

JOHN F. RIDER

LAST month we described how to use the Chanalyzer—new high-speed test instrument—in applying the "signal-test" system of servicing to detect and localize faulty operation of radio receivers. Instead of depending upon tests of "static" conditions in a defective radio receiver—tube terminal voltages, constants of components, continuity of circuits, etc.—a "dynamic" or action test of the receiver is made; the idea is that, if the signal (radio program, and so on) ceases or varies from normal at any point in a receiver, then that point is where you should logically start to look for the trouble. Only after having thus first localized the trouble by testing the circuit under as nearly normal operating conditions as possible, is the second step of checking on voltages, values, etc., in order.

Let us now continue with the description of the component elements of the Chanalyzer—the servicing instrument which has been designed to meet the individual requirements of the "signal-test" system of trouble-shooting—and its schematic circuit (shown on following page).

R.F.-I.F. CHANNEL (Cont'd.)

The R.F.-I.F. channel is resonated to the frequency of the R.F. or the I.F. circuit and it is possible to check the presence or absence of these signals, the level of the signal, and its character. The latter can be fed to a pair of headphones or to an oscilloscope if so desired. The indicator connected to this and the oscillator and A.F. channels operates upon the rectified signal picked up in these channels. In the case of the R.F.-I.F. channel, the rectified signal can be fed to earphones for aural observation; or to an oscilloscope for visual observation. The pick-up channel is free from distortion, hence a signal aurally or visually observed has the character of the signal (that is, whether it is intermittent, clear, mushy, with strong hum, etc.) at the point in the receiver (where R.F. or I.F. currents flow) where the probe is placed.

The output of the A.F. channel, unrectified, can be fed to earphones or to an oscilloscope for visual observation. As in the case of the previous channels, the level as well as the character of the signal can be established. Like the other channels, the A.F. signal can be picked up any place in the A.F. system. Thus it is possible to check for the output of phase inverter tubes to see that the input to the output push-pull tubes is equal. The same applies to voltages across the sections of push-pull transformers, etc.

The design of the voltmeter is such that it can be connected anywhere in the receiver circuit and it will indicate the proper polarity of the circuit without switching leads. Also, it can be connected to any point in the tuned circuits where a D.C. voltage exists without interfering with the signal in the circuit. For example, it can be connected to the control-grid of the R.F. mixer, or I.F. tubes to indicate the A.V.C. voltage, and as the receiver is tuned or the test oscillator tuning varied so as to vary the signal passing through the receiver, and so the A.V.C. voltage, the meter will indicate

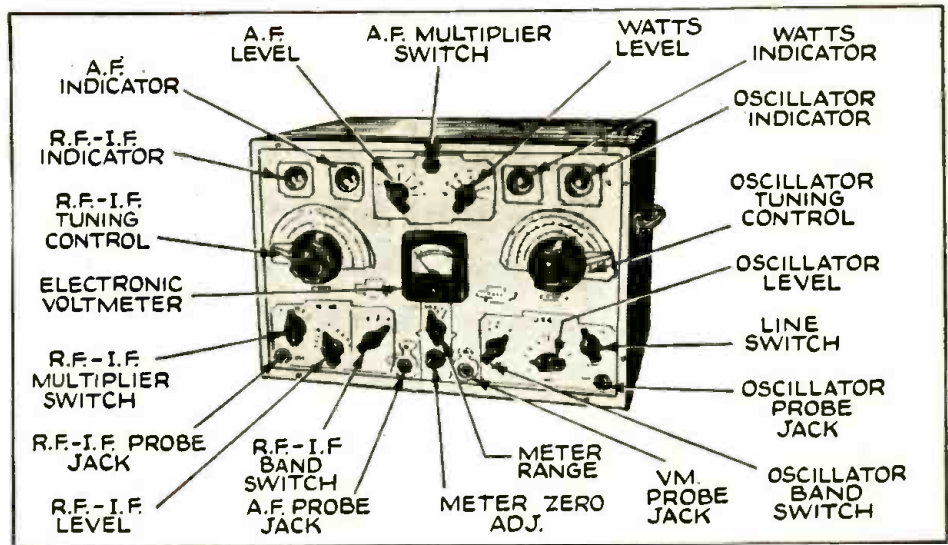

Fig. 4. The controls shown in photo, Fig. A, last month, are here identified.

the simultaneous variation in A.V.C. voltage at the control-grid of the tube being checked.

THE "WATTAGE" INDICATOR

The "wattage" (watts power) indicator channel is an important part of the system because, when used in conjunction with a test of the highest D.C. voltage in the receiver, as for example the voltage upon the plate or screen-grid of the output tube, it will immediately indicate the type of trouble in the event of a condition which loads the power supply, thereby increasing the watts consumption of the receiver. This "wattage" indicator is calibrated from 25 to 250 watts and is automatically brought into the circuit when the receiver is placed on test. Any abnormal or subnormal watts indication when combined with the D.C. voltage available from the power supply, immediately supplies definite information relative to the type of trouble in the receiver and whether or not a further test is possible.

Space does not permit of a resumé of what can be done with a system of trouble localization of this type, but if you appreciate the significance of being able to check the signal in any point in the receiver, you will readily realize the ease with which a defect can be located. In all cases where a test is possible, a signal is fed into the antenna circuit from any inexpensive test oscillator. If the receiver is "dead" the signal is traced to the point where it "dies" in the receiver. If the sensitivity is low, the signal is checked from stage to stage, from winding to winding, and observation made of the increase in signal strength as progress is made through the receiver. Simultaneously with these signal tests are made voltage tests in any place that is suspected; none of these voltage tests impair the operation of the receiver.

CIRCUIT IDENTIFICATION

Details which will make it more convenient to identify the various circuits of the complete schematic circuit of the Chan-

alyzer shown on the following page now follow. This diagram fulfills the requirements of (1) Universal Application; (2) Positive Identification; and, (3) Speed of Operation, as required in order to make the new test procedure practicable.

(Unless otherwise specified, all the resistors shown in the diagram, Fig. 5, are ½-watt units; and the condensers, 500 V. in mica, 400 V. in tubular, and 450 V. D.C. in dry-electrolytic types. Note that all other available information appears in the diagram or its caption.)

RADIO AND INTERMEDIATE-FREQUENCY CHANNEL

V1 to V5—Five tubes are employed in the R.F.-I.F. channel; 3 are high-gain tuned amplifiers, the 4th as a diode rectifier, and the 5th as an electron-ray indicator.

The amplifier covers 3 frequency bands: 600 kc. to 1,700 kc.; 240 kc. to 630 kc., and 95 kc. to 260 kc., the amplification being substantially flat over each band. The input-circuit is calibrated, thereby making the channel suitable for gain measurements.

A jack in the indicator circuit permits the output of the amplifier to be fed to headphones or an oscilloscope so that the signal can be heard or its waveform examined. The rectifier circuit is so designed that the output depends upon the carrier voltage and not the modulation component; therefore the indication does not depend on the percentage of modulation of the input signal.

OSCILLATOR CHANNEL

V6 to V8C—The oscillator channel employs 3 tubes; a tuned amplifier, a diode rectifier and the electron-ray indicator.

Coverage of oscillator operation extends as high as 70 megacycles. The tuned amplifier used in the channel operates over 3 frequency bands: 600 kc. to 1,700 kc.; 1,650

(Circuit on following page; text continued on page 314)

QUALITY TESTERS... at LOWEST PRICES

COMPLETE TUBE TESTING

Backed by a Reputation for Reliability since 1904... There are no Readrite orphans!



MODEL 432

Positively Checks Radio Receiving Tubes According to Latest Recommendations of Tube Engineers.

ONLY \$21.60

- Separate Plate Tests on Diodes and Rectifiers.
 - Neon Short and Leakage Tests.
 - Ballast Tube Continuity Test.
 - Uses Attractive Triplet Direct Reading Instrument 3 in. size. (GOOD-BAD) Scale.
 - Line Voltage Adjustment.
 - New Improved Low Loss Switch.
- Complete in attractive, sturdy quartered-oak case; suitable for counter or portable use. Sloping etched panel of silver and black. MODEL 431 checks all receiving tubes. (No ballast test). Tester uses dependable Readrite Meter. Quartered-oak case same as for Model 432. Dealer Price \$15.90

VOLT-OHM-MILLIAMMETERS



Model 735 \$10.80

Model 737 \$9.30

Model 736 A.C.-D.C. Tester \$12.00 Net

COMBINATION TESTERS

Model 640-740 FREE POINT TESTER and VOLT-OHM-MILLIAMMETER

Only \$28.35 net

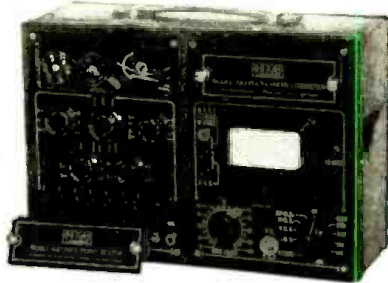

Readrite-Ranger Combination Testers are undoubtedly the best buy in precision testers. Besides the above, combinations may be had as follows:

- Model 442-540 Tube Tester and Signal Generator. Dealer Price \$36.90
- Model 442-740 Tube Tester and Volt-Ohm-Milliammeter. Dealer Price \$36.90
- Model 540-740 Signal Generator and Volt-Ohm-Milliammeter. Dealer Price \$37.50

HANDY PRECISION POCKET TESTERS

MODEL 736. A.C. and D.C. Pocket Tester Readings are: A.C. and D.C. Volts 0-15-150-750; D.C. at 1000 ohms per volt and A.C. at 400 ohms per volt; D.C. Milliampers. 0-1 1/2-15-150; Low Ohms. 1/2 to 1000; High Ohms. 0-100,000 at 1 1/2 volts. External batteries may be used for higher resistance measurements. Jacks are arranged to facilitate ease of operation. Has Triplet instrument.

The sturdy molded case has rounded corners: Size, 3-1/16" x 5-7/8" x 2-1/8". Attractive silver and black panel. All accessories including test leads, alligator clips, and instructions are included.

MODEL 737 D.C. readings only—ranges are: D.C. Volts 0-15-150-750 at 1000 ohms per volt; D.C. Milliampers 0-1 1/2-15-150; Low Ohms 1/2 to 1000; High Ohms 0-100,000 at 1 1/2 volts.

External batteries can be used for higher resistance measurements. Has Triplet instrument. Case same as Model 736. Furnished with complete accessories.

MODEL 735 ranges same as for Model 737 but operation is simplified by handy selector switch. Has Triplet instrument. Furnished with complete accessories.

BEWARE! Instruments with out jewels! Corrosion soon leads to gross inaccuracies. Don't buy from amateurs alone. See your jobber. Get his recommendation. His experience of years in the business plus a thorough knowledge of instruments is a safeguard for you.

SEE YOUR JOBBER . . . SEND FOR COMPLETE CATALOG



READRITE METER WORKS
1116 College Avenue, Bluffton, Ohio

Please send me more information on
 Model 432 Model 640-740 I am also interested in

Name

Address

City State

Please Say That You Saw It in RADIO-CRAFT

**EVERYTHING YOU NEED TO KNOW
IT'S COMPLETE!**

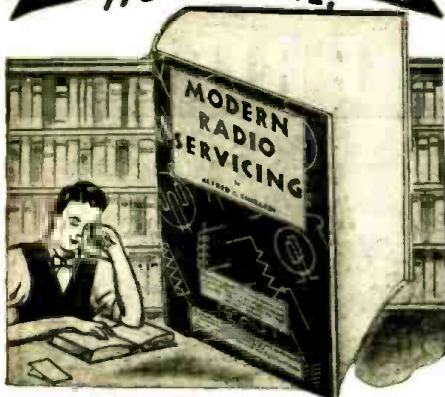

MODERN RADIO SERVICING
Ghirardi Tells You How

Here is your training in modern radio service work—complete in 1 big, convenient volume! Here's the place to learn the MOST-UP-TO-DATE "FACTORY" METHODS used today by the most successful servicing organizations in the country. Explains all about the use of the test instruments, how to spot set troubles, how to make repairs, etc., etc. The whole fundamental theory of servicing is presented to you in clear, easy-to-understand language, assisted by a wealth of illustrations. Read it at home in spare-time—then put it to work in your shop and watch the effect upon your income! **THE MORE YOU LEARN, THE MORE YOU EARN**—and Ghirardi is the man to teach it! This book is a "must" for every man in the servicing business. Don't put it off—fill out the coupon and mail TODAY! **MONEY-BACK GUARANTEE!**

- TEST EQUIPMENT**
420 pages of theory, descriptions of commercial instruments, diagrams, etc.
- REPAIRING**
184 pages of new time-saving methods for superhets, alignment, interference elimination, etc., etc.
- SPECIAL PROBLEMS**
281 pages on Servicing All-Wave sets; High-fidelity sets; Selling Service, etc.
- 1300 PAGES**

- A**
- B**
- C**

- TROUBLE-SHOOTING**
254 pages of latest short-cuts in tracking down all types of different receiver troubles.
- AVC and QAVC**
Servicing of these "tricky" circuits made clear and simple.
- CAR-RADIO**
Complete 114-page section covering every phase of autoradio installation and servicing.
- 706 ILLUS.**

Radio & Technical Publishing Co., 45 Astor Place, New York., Dept. RC-118.

Get this Mint of Knowledge NOW!

Here is \$4 (\$4.50 foreign) for my copy of **MODERN RADIO SERVICING**. Here is \$6.50 (\$7 foreign), the Special Combination Price for the above book together with Ghirardi's new **RADIO TROUBLE-SHOOTER'S HANDBOOK**.

Name.....
ADDRESS.....
CITY..... STATE.....
Please send free literature.

\$2.50 for BOTH Ghirardi Service Books

Be sure to read the **CLASSIFIED SECTION** which appears on page 316 of this issue

FREE!

HAMMARLUND 27th YEAR RADIO CATALOG

New 1939 catalog containing complete line of receiving and transmitting parts for the amateur and experimenter. Contains a wealth of technical data, drawings, curves, and illustrations. Write Dept. RC-11 for your copy.

HAMMARLUND MFG. CO., INC.
424-438 West 33rd Street, New York

TELEVISION—GOES TO HIGH SCHOOL

(Continued from page 270)

How could education assist in developing television? Here is the theory held by Walter J. W. Schiebel, principal of Dallas Technical High School: "If there were only 10 high schools in the entire United States teaching a course in television, possibly 100 young men endeavoring to find a place in the professional world would become interested enough to continue study, and who knows, one of those men might be another Edison in the world of television." It is said that genius comes in every generation.

"With high schools throughout the nation teaching television, it would be only a few short years before the younger generation would become television conscious," Principal Schiebel pointed out.

The Dallas high school students have learned that the operation of television is a relatively simple one. The transmitting set consists mainly of a bright lamp flashed upon a subject, a man for instance. *Photo-electric cells* record the light and dark sections of the man's face through a rapidly revolving disc, known as the *scanning disc*, changing the light energy into electrical pulsations which are sent out in radio waves.

Students learn that the receiving set picks up the pulsation and sends it through another scanning disc synchronized with that of the transmitter. The pulsation is recorded dark or light in a *neon glow tube*, in accordance with the other machine, which is constantly "picturing" the image of the man. The equipment shown in the photos is of the low-fidelity, mechanical-scanning type, and serves well to introduce beginners to the subject.

However, television is not ready for the general market. There are a number of technical problems which must be solved—*problems that will be overcome by men who are now only school boys*. Therefore, it might be well to predict that the youth now in high school will be among the first to realize that the day of television is actually at hand.

THE RADIO MONTH IN REVIEW
TELEVISION

(Continued from page 262)

scheduled to go on the air from the American House in Berlin, Germany, starting Oct. 1.

Suggests Marshall Wilder: "A recommended television transmission I feel would be 2 hours on the air and 2 hours off, 5 days per week. In this way the best interests of all concerned would be served."

In Germany, successful television has been accomplished over wires—the "Televisophone," *The Wireless World* (England) calls it—by amplifying the program as an intermediate frequency of 4.5 megacycles! Clever? This eliminates the need for coaxial cable. An infra-red flying spot is used to secure the requisite 441-line scan.

Private German manufacturers of television equipment are getting considerable financial aid in carrying on their development work (even though until Oct. 1 there never was any regular television transmissions) as a result of large purchases of commercial television receivers by the Government.

HOT OFF THE PRESS!
It's New!

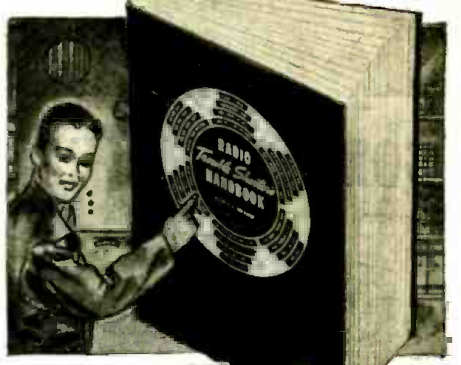

RADIO Trouble-Shooter's HANDBOOK
Ghirardi Does it Again

Once more Ghirardi has clicked! His new type of Handbook for radio service men is the greatest "SPEEDER-UPPER!" you ever saw! Here he gives you **dope** you need every day in your shop—Case Histories of nearly every set made, I-F's, alignment instructions, and loads of other equally valuable and practical reference data. What's more, he gives it to you in handsome fabricoid-bound manual form, specially arranged for **QUICK-FIND USE**. It duplicates no other service manual—it's the **ONLY** one containing this mass of freshly compiled, up-to-the-minute factory-checked material. You'll want a copy immediately—for it will pay for itself almost at once! No risk with our **MONEY-BACK GUARANTEE** back of you! So tear out that coupon and **GET IT MAILED RIGHT NOW!**

- CASE HISTORIES**
Trouble symptoms and remedies for over 2,000 sets, compiled from actual service records.
- I-F. PEAKS**
Over 12,000 listings for alignment of all superhets, old and new, including 1939 models and "copies."
- OTHER DATA**
Trouble-Shooting Charts; Servicing Receivers; Intercommunication Systems; P.A. Systems; Trade Directories; and over 100 other charts and tables on Tubes, Filters, Transformers, Grid-Block Resistors, IMA Color Codes, etc.

AUTO-RADIO
Gear Ratios and Dial Directions of Tuning Controls of all sets; Installation and Calibration System Data for all cars; Special Interference Elimination Instructions for over 80 car models; Electrical Wiring Diagrams.

OVER 500 PP. Standard Manual Size (8 1/2 x 11)

Radio & Technical Publishing Co., 45 Astor Place, New York., Dept. RC-118.

Get up to Date—ORDER NOW!

Here is \$3 (\$3.50 foreign) for my copy of **RADIO TROUBLE-SHOOTER'S HANDBOOK**.

Here is \$6.50 (\$7 foreign), the "Special Combination Price" for the above book together with **MODERN RADIO SERVICING**.

NAME.....
ADDRESS.....
CITY..... STATE.....
Please send free literature.

\$2.50 for BOTH Ghirardi Service Books

Get a Beautiful Desk Lamp Absolutely FREE!

Complete details as to how it is possible to get a beautiful desk lamp free appears on page 313 of this issue. **TURN TO THE ANNOUNCEMENT NOW!**

Now!

BALLAST REPLACEMENT
made **AMAZINGLY SIMPLE!**

Only 4 standard types of **Amperite AC-DC Regulators** will replace 90% (over 100 types) of **AC-DC Ballast Tubes** now in use!

WRITE FOR CHART AR.

New Low Price \$1.00 List

AMPERITE CO. 561 BROADWAY, N. Y.

AMPERITE AUTOMATIC REGULATORS

SUPERIOR PRESENTS 5 INSTRUMENTS

from its NEW 1100 series!!!! Never before has Superior offered so much for so little! Always the Best Buy in the Instrument Field, Superior in this new 1100 series gives you even more value! We have incorporated many refine-

ments, many new features . . . all proven to be sound and practical. We urge you to read the descriptions below carefully; see how these instruments fit your needs. Buy direct from manufacturer and save 50%.

THE NEW MODEL 1110-S A.C. - D.C. VOLT OHM MILLIAMMETER *A Midget in Size—A Giant in Performance*

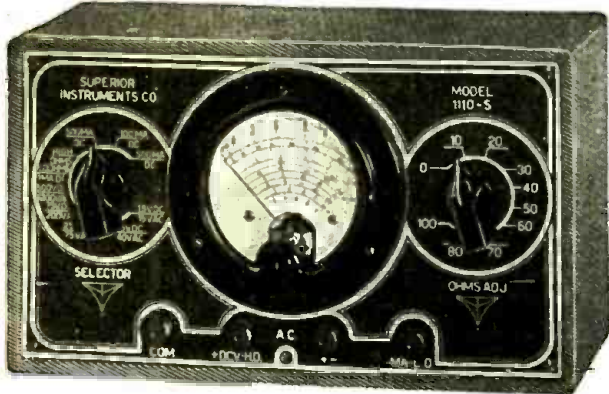

Features modern 0-1 d'Arsonval type meter, precision resistors, neat etched panel housed in new striped fabricoid case.

SPECIFICATIONS:

0-1.5 volts D.C.	0-500 ohms.....	500-500,000 ohms.	0-15 volts A.C.
0-15 volts D.C.	0-1 ma. D.C.		0-40 volts A.C.
0-25 volts D.C.	0-10 ma. D.C.		0-75 volts A.C.
0-75 volts D.C.	0-100 ma. D.C.		0-200 volts A.C.
0-500 volts D.C.	0-500 ma. D.C.		0-1200 volts A.C.

Model 1110-S supplied complete with batteries, test leads and instructions. Size: 8½" x 5" x 3¼". Shipping weight, 5½ pounds. Our net price.....

\$7⁸⁵

THE NEW MODEL 1130-S

Signal Generator with Audio Frequencies

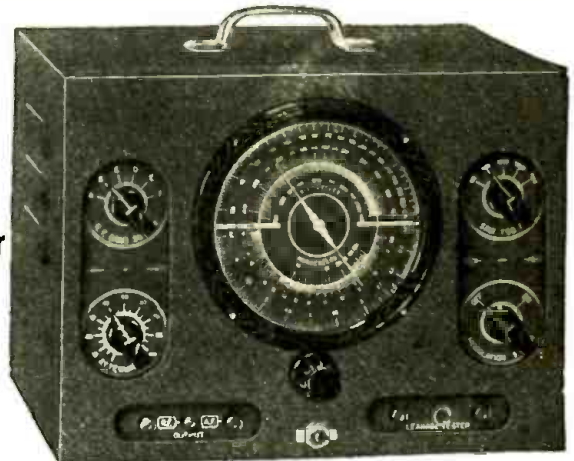

SPECIFICATIONS:

1. Combination R.F. and Audio Signal Generator. R.F. 100 kc. to 100 Mc., A.F.—100-7,500 cycles. All direct reading, all by front panel switching.
2. R.F. and A.F. output independently obtainable alone or with A.F. (any frequency) modulating R.F.
3. Accuracy is within 1% on I.F. and Broadcast bands; 2% on higher frequencies.
4. Audio frequencies in 5 bands: 100, 400, 1000, 3000, and 7500 cycles.
5. Giant airplane full vision, direct-reading dial.
6. Condenser and other leakages tested to 100 megohms.
7. All services on 90-130 volts A.C. or D.C. (any frequency).

Model 1130-S comes complete with tubes, test leads, carrying handle, instructions. Size 12" x 9" x 6¼". Shipping weight 15 pounds. Our net price.....

\$11⁸⁵

THE NEW MODEL 1150-S SUPER-ALLMETER

Featuring the New Sloping Panel



A genuine achievement! For accurate and rapid measurements. Note the following features: A.C. and D.C. Volts, A.C. and D.C. currents, Resistance, Capacity, Inductance, Decibels, Watts.

SPECIFICATIONS:

- D.C. Voltage: 0-15, 0-150, 0-750 volts D.C.
- A.C. Voltage: 0-15, 0-150, 0-750 volts A.C.
- D.C. Current: 0-1, 0-15, 0-150, 0-750 ma. D.C.
- A.C. Current: 0-15, 0-150, 0-750 ma. A.C.
- 2 Resistance Ranges: 0-500 ohms, 500-5 megohms
- High and Low Capacity Scales: .0005 to 1 mfd. and .05 to 200 mfd.
- 3 Decibel Ranges: -10 to +19, -10 to +38, -10 to +53. Inductance: 1 to 700 Henries, Watts.

Based on 6 mw. at 0 D.C. in 500 ohms. 100000 to 600 Utilizes new ¾" square 0-1 d'Arsonval type meter with precision resistors housed in our newly devised sloping case for rapid and accurate servicing.

Model 1150-S supplied complete with test leads, tabular charts and instructions. Size 10" x 7¼" x 4½", shipping weight 9 pounds. Our net price.....
Model 1150-A Portable carrying cover 75c additional.

\$11⁸⁵

THE NEW MODEL 1180-S SET TESTER

A Complete Laboratory All in One Unit!

Featuring Our New Type Sloping Panel for Precise and Rapid Servicing



A complete testing laboratory all in one unit! Combines Superior models 1140-S and 1150-S. For specifications read the description of both these models herewith. Comes housed in sturdy, black case with sloping panel for rapid and simple measurements. Complete with test leads, tabular charts, instructions and tabular data for every known receiving type tube, including many transmitting types. Size 11½" x 9¼" x 5"; shipping weight 18 pounds. Our net price.....
Model 1180-A for Portable Cover, add 95c.

\$17⁸⁵

THE NEW MODEL 1140-S TUBE TESTER



A really modern tube tester conforming to all standards of good engineering practice. Utilizes a 3" d'Arsonval type meter with calibrated scale. Furnished in a sturdy black case with sloping panel for easy operation. Removable cover and carrying handle for either portable or counter use.

SPECIFICATIONS:

1. Tests all 4, 5, 6, 7, 7L, and octal base tubes, including diodes.
2. Tests by the well-established emission method for tube quality; directly read on the GOOD? BAD? scale of the meter.
3. Affords separate neon test for leakage and shorts between elements.
4. All services performed by the use of only five controls at maximum, and many tests do not require working all the controls.
5. Supplied with instructions and reference table so that the filament voltage and emission measuring controls may be properly set for the enumerated long list of tubes, which includes all tubes commonly encountered in servicing.
6. Works on 90-120 volts A.C. 60 cycle.

Model 1140-S comes complete with instructions and tabular data for every known receiving type of tube as well as many transmitting (the types). Shipping weight 10 pounds, size 10" x 7¼" x 4½". Our net price.....
Model 1140-A with Portable Cover 75c additional

\$10⁸⁵

SUPERIOR INSTRUMENT CO. 136 Liberty St., Dept. 1138 NEW YORK, N. Y.

Please Say That You Saw It in RADIO-CRAFT

INTERESTED IN TELEVISION?

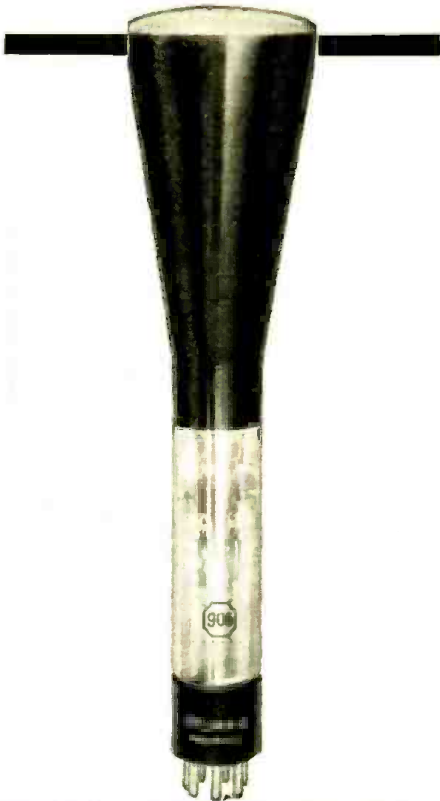

Sylvania announces cathode-ray picture tube type 906

If you are one of today's modern radio men . . . this announcement will prove of value to you. Sylvania's new television tube, type 906, has been especially designed for that small-sized receiver you plan to build. Its adaptable size—3" screen, over-all length, 12"—and the brilliance of its image make this cathode-ray tube ideal for your needs. And of course, type 906 is high in quality, like every other Sylvania tube.

Send the coupon today for technical data on this new tube. Hygrade Sylvania Corporation, Emporium, Pennsylvania. Also makers of famous Hygrade Lamp Bulbs.

SYLVANIA

Set-Tested Radio Tubes

HYGRADE SYLVANIA CORP.
Emporium, Pa. RC-118

Please send me technical data on television tube type 906.

Name

Address

City State

Dealer Serviceman

Amateur Experimenter

Name of Jobber.....

DEVELOPMENTS INCREASE RADIO'S VOCATIONAL APPEAL

(Continued from page 277)

requires the use of Auto Alarm Apparatus on board U.S.A. ships. Two types of equipment have been developed to meet the shipowners' demands and the requirements of the Department of Commerce, one by Mackay Radio and one by RCA. The principle of automatic alarm signaling as defined by this Conference is now accepted by all the large shipping nations.

Another administrative act of importance is the law passed by the Norwegian Storting. The law makes it compulsory for all ships above 1,600 tons to install radio apparatus in advance of October, 1937, instead of January, 1938, the date previously given. It also compels all Norwegian ships crossing the North Atlantic to be fitted with radio, irrespective of tonnage, and is a direct result of the usefulness of radio in saving human lives as exemplified by the spectacular rescues in the North Sea during the unusually heavy storms experienced in the winter of 1936-'37.

Communications with coastal cargo and passenger ships, as well as trawlers, are being handled mainly by radio telephony.

The tendency towards connections from radio telephone installations on ships to land telephone network is spreading. During 1937, the following new coastal radiotelephone stations were scheduled for regular service:

In Great Britain—Humber, Fleetwood and In Norway—Tjomo, Kristiansand, Bergen and two others;

In Sweden—Stockholm, Gothenburg and Herno-sand.

The carrier powers of the shore stations vary from 250 watts to 2,000 watts. Crystal control is employed on several of the new stations.

The use of radio aids to marine navigation is rapidly spreading. New *radio direction finders* for small ships were introduced in the U.S.A. by Mackay Radio and RCA. These direction finders cover ships communication and marine beacon bands.

Certain of these types of direction finders for small ships introduced by the International Marine Radio Company, Ltd., London, and the Marconi International Marine Company, Ltd., London, cover in addition the 80-200 meter bands. This enables the smaller cargo and passenger ships, and especially trawlers, seal and whale catchers, to take bearings on fixed and mobile stations working within this new band.

In Europe the use of medium-wave range beacons to guide ships through narrow channels is spreading. In Finland one such beacon has been put into service at Grohara and another is on order for Rodhamn. The beam has a spread of about 4° and results from the combined action of a Bellini-Tosi system of crossed loops and a vertical antenna.

AVIATION RADIO

For communication purposes the tendency is to use higher-powered transmitters both on medium- and shortwave bands. The reasons are 2-fold: (1) a better signal strength is generally required on both wavebands; and, (2) the air transport companies wish to eliminate the 70 meter trailing aerial used extensively for the medium-wave services.

The K.L.M., the Dutch air transport company, in 1937, introduced 200-watt equipments for medium and short-wave telegraphy on their routes to Batavia. On the European routes the medium wave only is used. The Swedish Company, A.B.A., fitted Lorenz 150-watt equipments on their new Douglas DC-3's, and it is understood that Imperial Airways is using powers of the same order on aircrafts serving the routes to the Far East and South Africa.

Standard Telephones and Cables, Ltd., London, has completed the development of a radio-telephone equipment for lighter aircraft. Crystal-control of 4 fixed frequencies is used for both the transmitter and receiver; and although the output power is on the order of 3 watts the ranges obtained, when working with a ground station having an output power of 7 watts and similarly controlled, are remarkable. Another notable feature of this set is its remote control system which is electrical throughout. The weight is very low.

In the field of air navigation the following are of special interest:

(a) The introduction of the "Z" and "sheet" marker beacons along the radio routes in the

U.S.A. Frequencies of the order of 75 megacycles are used.

(b) The acceptance of the Australian authorities of a plan for using U.-S.W. frequencies for *range navigation* as well as for *blind approach beacons*. This scheme was proposed by C. Lorenz, A.G., and demonstrations were carried out at Essendon, Australia, by Standard Telephones and Cables (Australasia), Ltd.

(c) The installation and demonstration of the Lorenz blind approach system at Indianapolis, Indiana, U.S.A. The demonstration proved that a practical system for this purpose exists.

The Lorenz system is in extensive use in Europe where about 18 installations are completed and 11 are under construction. Outside of Europe installations have been completed or are under construction at Tokyo, Mukden, Indianapolis, Buenos Aires, Cape Town and Melbourne, as well as at 7 other aerodromes in Australia.

Due to the crowding of airports in Great Britain and other countries, Lorenz in 1937 introduced a new receiver having 3 spot frequencies which may be rapidly selected. Thus the pilot is enabled to choose the correct main signal frequency of the airport where he wishes to land. The following main signal frequencies were agreed upon at the conference of C.I.N.A. held in Paris in June 1937: 33,333, 35,333, and 36,333 kc.

Standard Telephones and Cables, Ltd., London, has developed for aircraft a blind approach receiver, of the superheterodyne type, with 6 fixed frequencies. This receiver is highly selective.

New models of the R.C.5 Busignies Automatic Radio compass have been produced by Standard Telephones and Cables, Ltd., London, and by Le Material Telephonique, Paris. The most important changes are (a) the extension of the frequency range to include the band from 150 to 1,500 kc., thus enabling the pilot to take bearings on broadcast stations in both bands, and (b) improvements in the remote tuning control.

Experiments have been carried out with the Simon automatic compass which depends for its operation on 2 circuits having identical electrical properties.

Standard Telephones and Cables, Ltd., has also completed the development of a small, hand-operated, loop direction finder combined with a "homing" course indicator. The loop is protected by a streamlined housing; and, due to its small dimensions, the drag at any aircraft speed employed today is negligible. The weight and space requirements have been reduced to a minimum, thus permitting its installation in aircraft for itinerant fliers.

In France, the policy of using ground direction finders was adopted by the Air Ministry some years ago. In the spring of 1937, an order for 24 Standard Adecock equipments, type R.C.6-A, was placed for civil and military airports.

In the field of ground direction finding systems, the German authorities also are proceeding with the installation of "H"-type Adecock direction finders. The installation at Hanover, Germany, has been completed and is reported to be giving satisfactory results.

The Swedish Telegraph Administration installed a Standard Adecock direction finder for the Jonkoping airport, as a result of the success of the 1936 installation at the Norrkoping airport.

The Marconi Wireless Telegraph Co., Ltd., in 1937, introduced a short-wave Adecock direction finder. Its principal practical use has been in connection with the trial flights across the Atlantic.

In the U.S.A., work of importance was carried out during the year on the elimination of static interference with radio reception. The solution of this problem is of the greatest importance to air line operators everywhere; and, with the knowledge resulting from the fundamental studies now completed, a satisfactory cure for this type of interference may be obtained in the near future.

TUBES

Progress in the thermionic tube art was mainly directed to improvements in existing types and to the extension of the frequency range over

Please Say That You Saw It in RADIO-CRAFT

which tubes can be made to operate. Increased demands obtained for tubes operating at ultra-high-frequencies, and much effort has been devoted to their development. As is now well known, one of the requirements for such tubes is that the transit time of the electrons in traveling from one electrode to another must be short.

By careful design, the range at which negative-grid triodes will continue to function has been increased considerably beyond the previously accepted limits of oscillation. Notable advances in this direction have been achieved by the Bell Telephone Laboratories, where *negative-grid triodes* have been oscillated at frequencies as high as 1,500 megacycles per second with an output of 2 watts. These frequencies have been made possible by the use of double leads to grid and anode, contrasting with the frequency of 650 megacycles per second obtained by the W. E. 316-A tube at an output of 2 watts. Small electrodes with extremely small separation are used in the new tubes.

By making use of the "micromesh" principle of construction, the Standard Telephones and Cables Valve Laboratory, London, has produced an indirectly-heated tube capable of giving an output of over 10 watts at a frequency of 230 megacycles. Although the frequencies so far attained for this type of tube are far from those recorded above, it is worthy of note that this particular tube is of such a size as to make its construction much simpler.

A water-cooled tube, the RCA 888, for operation at frequencies as high as 300 megacycles, was announced in 1937. This represents a considerable advance in water-cooled tube technique for high-frequency operation; and, although the output at 300 megacycles is small, at 150 megacycles 100 watts can be obtained.

Development of wide-band transmission systems places stringent requirements on the tubes used. So far, advances have been made by improvements along more or less conventional lines. The principal aim for the initial stages of wide-band amplifiers for repeaters, etc., has been to produce tubes having a high ratio of slope to interelectrode capacity. In addition, the output tube must be capable of delivering from 1 to 5 watts into a comparatively low resistance, thus placing considerable demands on cathode emission.

Steady improvement continues in electronic devices, such as television "iconoscope" and "kinescope" tubes. These *cathode-ray* methods of pick-up and reproduction, respectively, still hold a predominant position.

The size of the tubes used in radio broadcast stations continues to increase. Whereas not many years ago valves having peak power outputs of 40 kw. were almost unknown, tubes capable of delivering peak powers of 100 kilowatts are now in successful operation. Les Laboratoires, Le Materiel Telephonique, Paris, has developed a tube, the type 3067-A, which has a power handling capacity of 200 kw., peak. These tubes are of the "sealed-off" or *permanently-evacuated* type; and it is quite possible that still higher powered tubes of this type will be produced. High-powered tubes of the *continuously-evacuated* type are undergoing trials, but it is not yet by any means certain that they will displace the sealed-off types as higher powers are called-for.

There is a growing tendency to use tetrodes and pentodes for transmission purposes. During the year, *radiation-cooled* pentodes with an anode dissipation of 1 kilowatt have become available, and the development of *water-cooled* tetrodes is being actively carried out. Just how far high-power tetrodes will progress is problematical, but the indications are that very large tubes of this type may become available within the next few years.

No outstanding developments in tubes for radio broadcast receivers occurred in 1937. Changes have been limited mainly to modifications of known types. Perhaps the most noteworthy feature was the rise to popularity of the so-called "beam" tube (at the expense of the conventional pentode).

RADIO BROADCAST RECEIVERS

The past year has been one without any startling innovations, the only marked feature being the general adoption of at least one short-wave band in almost every receiver. Otherwise the general trend of development has been towards a simplification of the controls which have to be operated by the listener and, particularly in the more expensive sets, an extension of the functions carried out by automatic means.

(Continued on page 302)



I'm glad I waited for this FREE CATALOG!



In fact, I use it as my buying guide. Its 188 pages are crammed with radio, camera and appliance values that save me real money. And shopping at home sure saves me plenty of time and trouble. You ought to send for your copy right away.

1939 LAFAYETTE RECEIVERS

The biggest radio values of them all! Sleek, new, styled to the minute beauty — clear, powerful, realistic reception — perfected touch tuning — Lafayette for 1939 combines all the extra-value features you'd expect to find only in much higher priced sets. Listen to Lafayette before you buy any new radio. Select from 50 brilliant models described and illustrated in our new FREE catalog.

PARTS, TUBES AND KITS

Whether you build it yourself or fix it yourself, this book has everything you need. Parts — tubes — hard-to-get items — the most complete line of receiver kits in radio. Use our FREE catalog for easy, economical shopping.

PUBLIC ADDRESS EQUIPMENT

Lafayette P.A. is doing smash business everywhere! This year, there is a Lafayette unit for every sound purpose. New performance... the same old thriftness. See the complete P.A. line in our new catalog. Special List Price P.A. Catalog for servicemen. Write to P.A. Division.

HAM EQUIP'T & APPARATUS

Save important money on quality ham equipment! Select your favorite transmitter... all the accessories you need, from this value-packed radio catalog.

To give you an idea of what this big FREE catalog (just published) will mean to you, we've listed at the left a few of the items it contains. But this doesn't tell you half the story. There is, for example, the new television kit, designed to "let you in" on things to come, give you some practical experience with the radio equipment of tomorrow. You'll want to see it, and you'll be surprised at how little it costs. There's the new camera section featuring all the leading makes of cameras for amateur and professional, as well as complete photo equipment and supplies. There are tools and every conceivable electrical appliance for home and workshop. Here's a catalog that's value-packed from cover to cover. Send for your FREE copy at once!

You save on everything you buy. You have more than 50,000 items to choose from. You get value far beyond price.

BUY BY MAIL OR IN PERSON
Either way, you benefit. Delivery service is rapid. Our staff understands your problems.

7 branches to serve you
WHOLESALE RADIO SERVICE CO. INC.
NEW YORK, N. Y. • CHICAGO, ILL. • ATLANTA, GA.
100 SIXTH AVENUE 901 W. JACKSON BLVD. 265 PEACHTREE STREET
BOSTON, MASS. • BRONX, N. Y. • NEWARK, N. J. • JAMAICA, L. I.

VALU-BILL Says:

Just paste 'er on a penny post-card and mail. If you don't say it's the best one cent investment you ever made, we'll refund your money! Don't wait.



Send for it today!

WHOLESALE RADIO SERVICE CO., INC.
100 Sixth Avenue, New York, N. Y.
Rush FREE 1939 Catalog No. 73-3LB

Name _____
Address _____
City _____ State _____

Please Say That You Saw It in RADIO-CRAFT

PROTECTION

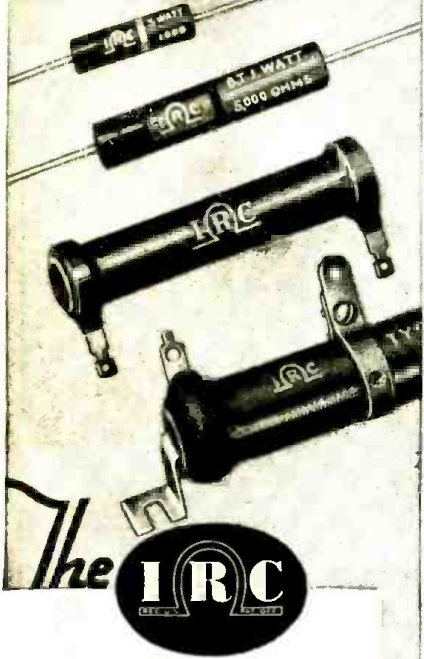

Secret of TROUBLE-FREE RESISTORS

It is a matter of record that nine out of ten resistor breakdowns are caused solely by failure of the protective covering, either in its job of keeping moisture from the element, or in dissipating heat properly.

... It is also a matter of record that the outstanding popularity of IRC Resistors results in no small part from their perfection in this respect. Hand in hand with engineering improvements inside of the resistors themselves, IRC has pioneered and perfected BOTH Molded phenolic insulation for IRC BT Metallized Resistors and other types, as well as the famous Cement Coating for heavy duty power wire wounds.

By whatever test you choose to make—even boiling hot and freezing cold salt water immersion—you'll find these IRC protective coatings supreme.

"They Stay Put"

INTERNATIONAL RESISTANCE COMPANY
 401 N. Broad St., Philadelphia, Pa.
 In Canada, 187 Duchess St., Toronto, Ont.

BUILD THIS POCKET-SIZE 3-TUBE HEARING-AID

(Continued from page 269)

pleted chassis is held in place against the bottom of the case by 2 screws entering it from the bottom.

Wiring is commenced by connection of the filament circuits (Follow schematic diagram, Fig. 1, or pictorial diagram, Fig. 2). Practically all of the remainder of the wiring is done by use of the pigtailed on the condensers and resistors. Spaghetti tubing of small size should be used liberally to cover all the bare leads.

Study the base diagrams (Fig. 3) of the tubes carefully before any wiring is started. Note that on the XVS type, the cap is the plate connection, while on the XPD, the cap is the triode grid, as in our American tubes.

It will be seen that the parts layout chosen provides the most direct path through the amplifier for the electrical waves to travel, starting at the base of V1, where the input grid is located, and ending at the base of V3, where we find the output plate.

After the filament wiring, the next circuit to tackle is that leading from the control-grid of V1 to the diode plate of V3. The units of this circuit run along the inside end of the chassis beneath the bases of V1 and V3 affording the shortest possible path.

Note that the 0.002-mf. coupling condenser from V1 to V2 is outside of the chassis at the socket terminals of V2, while the coupling condenser and associated resistors between V2 and V3 are located between these tubes physically, the condenser connecting from the plate cap of V2 to the grid cap of V3.

Three flexible leads are required to connect the batteries and these may be color coded if desired to provide easy identification, the "A-" and "B-" lead being common. The filament dropping resistor may be between 3.5 and 5 ohms and is not at all critical.

Upon completion and checking, the amplifier should work right off, when the proper accessories have been connected. Since there are no adjustments to make, improper oper-

ation can only mean poor components or wrong connections, so use the best parts and the greatest care throughout.

How the outfit is carried on the person is a matter of individual preference and need not be gone into here. (A suggested method is illustrated in Fig. A.) Suffice it to say that the various parts may be fastened to a belt or they may be carried in a moderate-size lady's handbag, or in other ways that will suggest themselves to the user.

LIST OF PARTS

Tubes
 Two H1VAC type XVS tubes;
 One H1VAC type XPD tube;
 Three H1VAC 4-prong Hyvac-tube wafer sockets.

Resistors
 Four I.R.C. 10 megohm, 1/2-W. resistors;
 One I.R.C. 20 megohm, 1/2-W. resistor;
 One I.R.C. 1 megohm, 1/2-W. resistor;
 Two I.R.C. 2 megohm, 1/2-W. resistors;
 Two I.R.C. 0.15-meg., 1/2-W. resistors;
 Two I.R.C. 0.5-meg., 1/2-W. resistors;
 Two I.R.C. 30,000 ohm, 1/2-W. resistors.

Condensers
 Three Solar 0.1-mf. 200 V. tubular condensers;
 Two Solar 0.25-mf. 200 V. tubular condensers;
 Four Solar 0.005-mf. mica condensers;
 Two Solar 0.002-mf. mica condensers;
 One Solar 500 mmf. mica condensers.

Miscellaneous
 One S.P.S.T. toggle switch;
 One Carter 15,000-ohm midget potentiometer;
 One I.R.C. 5-ohm wire-wound resistor;
 Four phone tip jacks;
 One Thor Radio Co. plastic case, 6 3/4 x 1 3/4 x 3 3/4 ins. wide;
 One Eveready No. X2 733, 45 V. battery;
 One Eveready No. X2 722, 3 V. battery.

Most Radio mail order houses can supply these items if properly identified as to title of article, issue (month) of *Radio-Craft* and year.

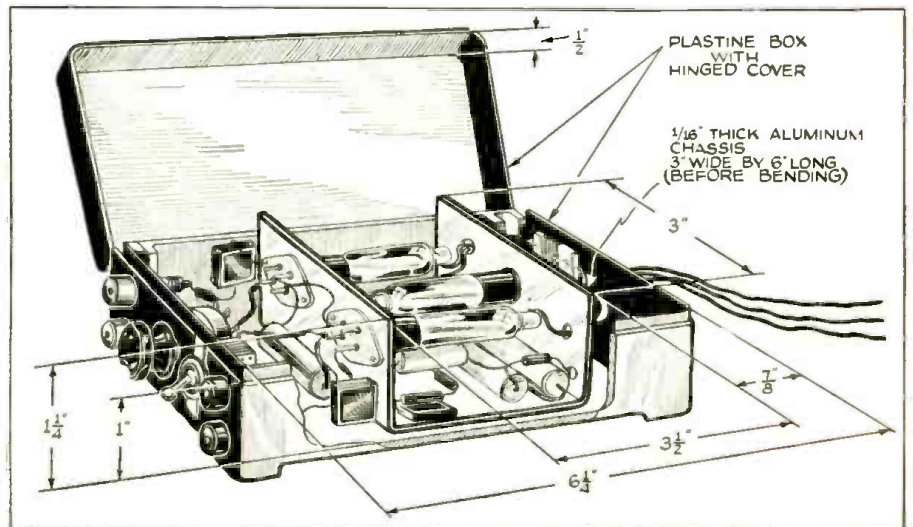

Fig. 4. Layout of main components and dimensions of the chassis and case.

BUILD THIS BEGINNER'S "BREADBOARD SPECIAL"

(Continued from page 281)

- One IRC carbon resistor, 2 megs., 1/4-W.;
 - One Micamold trimmer condenser, 100 mmf.;
 - One Aerovox mica condenser, 100 mmf.;
 - One Hammarlund 6-prong isolantite socket, type S-6;
 - One Sylvania type 1231 tube;
 - One Sylvania Special Octal Socket for above tube;
 - One 7-post binding-post strip;
 - One home-made baseboard;
 - Two knobs with pointers;
 - Miscellaneous hardware.
- Most Radio mail order houses can supply these items if properly identified as to title of article, issue (month) of *Radio-Craft* and year.

Please Say That You Saw It in RADIO-CRAFT

LATEST SIDELINE FOR SERVICEMEN ELECTRIC FENCE UNIT

(Continued from page 284)

Fig. 2A—Condition of no-load on the fence control unit. Note that the transient voltage is many times greater than the actual voltage produced on the secondary of the transformer. The actual voltage of about 150 volts corresponds to the limited excursions of the line, while the transient voltage of about 1,400 volts is indicated by the extended, peak lines.

Fig. 2B—Condition with fence control unit loaded with equivalent 100,000-ohm resistance. This corresponds to 5 miles of well-insulated fence. Note that the transient voltage has dropped, but is still about 500 volts. Stray harmonics of higher frequencies are also present, but these are low in intensity.

Fig. 2C—A 5,000-ohm resistor in output circuit of the fence control. This condition corresponds to a partial short caused by a moist contact. Note that the transient voltage is missing, and the effective voltage present is within the safe limits. The transient voltage is quickly reduced by a shorted condition, but its presence is first felt as a strong shock.

An inexpensive, non-synchronous vibrator may be used and this unit will operate continuously for years because of the low current load placed on the contacts. The current consumption under no-load condition is about 1/3-ampere, rising to about 1/2-ampere under shorted condition.

After the fence is in use for a short period of time the animals will learn to keep away from the wire. In this manner the unit may be shut off for days at a time conserving the battery.

LIST OF PARTS

- Ten feet battery cable;
- One metal cabinet;
- Two battery clips;
- One "on-off" toggle switch;
- One sub-panel Edison socket;
- One 1/2-watt neon bulb;
- One 25,000-ohm, 1-watt resistor;
- One 6-volt vibrator;
- One fence control transformer;
- One stand-off insulator;
- One fahnestock clip;
- One 4-prong baseboard socket.

This article has been prepared from data supplied by courtesy of Allied Radio Corp.

EMERGENCY RADIO TRAILER OF THE AMERICAN LEGION

(Continued from page 273)

The 20-line telephone switchboard, the testboard, gas engine, generator, etc., are carried in the rear end of the trailer; inside view shows the front end which carries the radio equipment and Morse (line-telegraph) set-up.

Our American Legion Radio Club has just received license and call WSSHQ, and we have applied for membership in the A.A.R.S. net. We will use the same equipment as WANC, but we will then operate on the regular Army net frequencies, 3,915 and 3,520 kc.

Our station is operated each Monday night from 8 to 10 P.M. (now E.D.S.T.) and we are very glad to contact amateur radio stations on any frequency. Glad to send QSL cards and appreciate all reception reports. Glad to make special schedules.

SEE

for Yourself!

The RIDER Chanalyst



Sensational Trouble-Shooting Instrument Now Being Demonstrated By Your Jobber

- See** How you can check any point in the receiver, no matter what it may be, simply by placing the proper probes at the points under test!
- See** How you can determine the existent trouble, almost immediately, by merely moving the probes from one point to another!
- See** How you trace the passage of the signal through the receiver and establish the points where signal exists, becomes distorted, fades, dies, takes on hum, without interfering with the normal operation of the receiver!
- See** How any and every check of the operation of the audio-frequency channel is made with the use of a single probe!
- See** How the Electronic Voltmeter enables you to measure all d-c voltages in any part of the receiver by the use of only one probe in conjunction with a common ground.
- See** How you can conduct any and every test in the RF and IF channel, easily, quickly and accurately!
- See** How the oscillator channel is checked by placing the proper probe in contact with any portion of the oscillator tuned circuit and resonating the channel to the frequency of the signal being generated by the oscillator.
- See** How the Intermittent Problem is solved with the Rider Chanalyst . . . How you can, in effect, divide the receiver into five separate sections, and definitely localize the trouble as being in a certain part.
- See** The multitude of other tests you can conduct with the Rider Chanalyst. It involves no unknown principles of radiol
- See** This sensational new instrument demonstrated by your jobber.

SERVICE INSTRUMENTS, INC.
404 FOURTH AVENUE • NEW YORK CITY



JOHN F. RIDER
in whose Successful Servicing Laboratories this revolutionary instrument was developed.

SEE IT DEMONSTRATED TODAY

Free
16-PAGE
DESCRIPTIVE
BOOKLET
SENT ON REQUEST

Please Say That You Saw It in RADIO-CRAFT

A CLOSEOUT DIRECT TO YOU
of One of America's
Smartest Portable Radios
A SUPERHETERODYNE BATTERY RECEIVER

REGULAR SELLING PRICE

\$33.50



WHILE THEY LAST! **\$21.95** — MODEL RC-15 COMPLETE WITH TUBES AND BATTERIES.

MODEL RC-15, one of radio's finest models, is the most compact unit on the market. It is housed in a modern striped, airplane fabricoid case, with removable hinged cover. Use it on ● FARM ● AUTOMOBILE ● BOAT OR CANOE ● LAWN PARTIES ● OUTINGS ● TRIPS ● BIKES AND MOTORCYCLES . . . and as a reserve set while the regular set is in use. It utilizes the following features:

- R.C.A. Licensed
- Noise Suppression
- Vernier Drive Dial
- No Aerial Necessary
- Automatic Volume Control
- Weight, including batteries, 15½ lbs.
- Four high-efficiency, multi-purpose tubes equivalent to a seven-tube set.
- Full Over-size Dynamic Speaker.
- Six Tuned Circuits for Sensitivity and Fidelity.
- Types of Tubes Used Are: 1C7G, 105GT, 1F7G, 1F5G.
- Utilizes three 230N "B" Burgess Batteries, one 4F2H "A" Burgess Battery, one 5360 "C" Burgess Battery.

EASTERN RADIO & TELEVISION CO. 136 LIBERTY STREET
NEW YORK, N. Y.

DEVELOPMENTS INCREASE RADIO'S VOCATIONAL APPEAL

(Continued from page 299)

RADIO BROADCASTING (INCLUDING SPEECH INPUT EQUIPMENT)

Progress in the field of radio broadcasting, apart from television, was characterized not so much by the announcement of new developments as by the continued and intensive application of existing technique to practical service.

In Europe the trend towards higher powers continues to be marked and, among other countries, Belgium, Holland, Lithuania and Turkey must be added to the list of countries which are either arranging for or actually installing new stations of 100 kw. rating and upward. In some instances entirely new stations are provided, while in others it is a case of extending an existing station which is the fortunate assignee under the Lucerne Plan of an unshared wavelength, the maximum exploitation of which is most desirable. The extent to which this trend towards high power has already made itself felt is shown by the fact that about 1 in 7 of the 250 existing medium- and longwave stations in Europe and Northern Africa are now rated at 100 kw. or over, and about 1 in 4 at 50 kw. or over, while 55 per cent have a rating of not less than 10 kw. In the United States, where broadcasting does not receive financial support from government sources, the use of high-power stations is not so widespread; but transmitters with outputs of 50 kw. are not uncommon and manufacturers have in hand designs for powers up to 500 kw. (with W1W in Cincinnati now operable with up to 700 kw.—Editor).

In Great Britain the British Broadcasting Corporation have opened a new medium-wave "Regional" station of 80-kw. rating at Stagsshaw. This station, which was supplied by Standard Telephones and Cables, Ltd. (London), employs the modern high-efficiency method of final-stage class B modulation. A similar station is to be erected at Start Point in South Devon.

The British Broadcasting Corporation has further extended the utilization of synchronized carrier operation and now has 3 groups of 2 stations and one of 3 stations operating on this method. Individual tuning fork control of the master oscillator is used at each station in a group, the tuning fork being itself held in step with a master fork to which it is connected over the telephone cable network.

The Norwegian Administration has introduced synchronized carrier operation for a group of 3 stations and contemplate further extensions of the system. The local oscillators are held in step by periodic application of a synchronizing signal sent from the master station over wire lines.

Shortwave long-distance broadcasting services have recently assumed considerable importance as may be gauged from the fact that there are already over 100 specific wavelength assignments for this purpose. Here again increase in station power is very noticeable. There are now some 30 stations rated at 10 kw. or over.

At Daventry the British Broadcasting Corporation has added 3 new transmitters for the "Empire" service, 2 being rated at 50 kw. carrier output at 22 megacycles. These 2 transmitters were supplied by Standard Telephones and Cables, Ltd., London, and were brought into service in time for the worldwide broadcasting of the ceremonies at the Coronation of H.M. King George VI. They are designed for rapid selection between 4 preset wavelengths, and operate on the high-efficiency class B final-stage modulation system. Another interesting feature is the use of "inverted" radio-frequency amplifiers.

A transmitter of similar type is now being manufactured in Italy by Fabbbrica Apparecchiatura per Comunicazioni Elettriche, Milan, for the Rome station of the E.I.A.R. (Italian Broadcasting Co.). It will have a rating of 100 kw. This station will also have a second 100 kw. and a 50 kw. transmitter, making 3 powerful shortwave sets in all.

In Austria RAVAG will install a 50-kw. shortwave station which will be manufactured by Czeija Nisl and Company, Vienna. The 100-kw. medium-wave station at Ankara, Turkey, will be supplemented by a 20-kw. shortwave station, while Switzerland and other countries are contemplating high-power shortwave transmitters for similar service.

The provision of broadcasting service in India,

Be sure to see this big new catalog!

Ask your Jobber to show it to you

Get the equipment you need to do MORE business

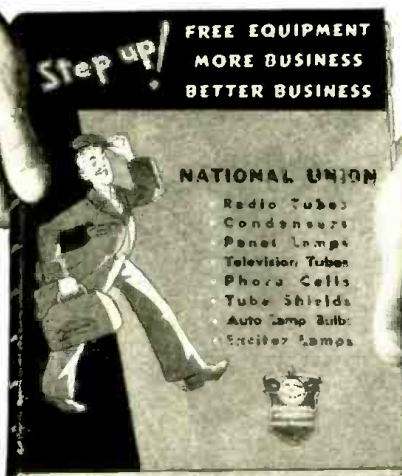

better business this year FREE with purchases of **NATIONAL UNION** Radio Tubes & Condensers

NATIONAL UNION RADIO CORP.
NEWARK, NEW JERSEY

for nearest Distributor's name write

RADIO ENGINEERING ELECTRIC EYES



RCA Institutes offer an intensive course of high standard embracing all phases of Radio and Television. Practical training with modern equipment at New York and Chicago schools. Also specialized courses and Home Study Courses under "No obligation" plan. Catalog Dept. RT-38.

RCA INSTITUTES, Inc.

A Radio Corporation of America Service
75 Varick St., New York 1154 Merchandise Mart, Chicago

WE can supply complete Electric Eye at low cost or can supply relays, photo cells and other parts for any Electric Eye device also for Photo Electric Burglar Alarms at reasonable prices. Infra red filters for producing invisible light can be supplied at 25c each. These are 3/8" in diameter and will fit our standard light source. Special photo electric devices built for any purpose.

ELECTRONIC PRODUCTS CO., St. Charles, Illinois

Please Say That You Saw It in RADIO-CRAFT

under the aegis of "All-India Radio", has now been placed on a firm basis. The plans provide for services on medium wavelengths, for some of the larger cities, and on short wavelengths for general dissemination over the whole Peninsula. A total of 13 stations has so far been projected; of these, 8 will be on medium wavelengths, serving the cities of Delhi, Lucknow, Lahore, Trichinopoly, Dacca, Madras, Bombay and Calcutta; 4 will be on short wavelengths and located at Delhi, Madras, Bombay and Calcutta, for regular transmissions; while still another shortwave station, located at Delhi, will be used for special transmissions. The scheme includes the existing medium-wave stations at Delhi (20 kw.), Bombay (1.5 kw.) and Calcutta (1.5 kw.). The new medium-wave stations are to be of 5 kw. rating, while the shortwave stations will be of about 10 kw. rating.

The Australian Government is continuing its plan of increasing the broadcasting service, and 4 new 10-kw. medium-wave transmitters are being manufactured by Standard Telephones and Cables (Australasia), Ltd. The number of class B advertising stations has also been increased and several old stations have been modernized.

South Africa has ordered the first 2 relay stations planned to provide service to outlying points not well served by the central stations.

The design of studio and speech input equipment can now be said to be stabilized on the basis of main power supply to all amplifiers except perhaps those immediately following the microphone. In some cases the amplifiers use indirectly-heated tubes, and each amplifier has its own A.C. power supply unit with rectifiers for plate and grid supply; in other cases directly-heated tubes are used with rectified A.C. smoothed by floating batteries, this arrangement having the advantage of providing in itself an emergency supply system to care for short-period interruption of the main supply system. The carbon microphone has been almost wholly replaced by microphones of the electrodynamic or ribbon pattern, and both directional and non-directional types of microphone are now used. Recording apparatus for either disc or tape is usually installed as an essential part of the equipment.

Following the improvements which have been made in recent years in the transmission qualities of telephone cable systems, the policy of partial or complete centralization of studios has been adopted almost universally. An example of such centralization is that of the Belgian Institut National de Radiodiffusion, which has recently placed an order with the Bell Telephone Co., Antwerp, for the complete equipment of a group of 23 studios at the I.N.R. headquarters in Brussels. The equipment required uses indirectly-heated tubes with individual amplifier power packs, and includes separate control positions for each of 21 studios, a large bank of output and monitoring amplifiers and a recording room, together with central control and distribution positions. Connection between the various studios and control positions for program, monitoring or control purposes, and their connection to the outgoing lines for distribution to the stations serving the French and Flemish-speaking zones of Belgium, as well as to the shortwave station serving the Belgian Congo, etc., are all made through a special rotary automatic exchange equipped with elaborate signaling and interlocking circuits. An 80-db. amplifier signal-to-noise ratio is specified, together with a 100-db. signal-to-crosstalk ratio.

A few years ago the "relaying" of a program from one country to another was an exceptional event. Today it is commonplace, and concerts, observers' reports and items of special interest are every week passed over the international telephone network to be broadcast as a matter of routine in some country other than that in which the item originated. In the broadcasting of the Coronation ceremony of H.M., King George VI, however, the year witnessed a relay of unusual magnitude, in which the broadcasting authorities of no fewer than 20 different countries relayed the program directly from London through their own stations.

ROSS A. HULL—DEAD

As we go to press we hear of the untimely death of QST Editor Ross A. Hull. Mr. Hull was electrocuted accidentally while experimenting with high-voltage radio apparatus at his home. The entire radio fraternity mourns a great editor and true experimenter.



BACKED BY RADIO'S STRONGEST GUARANTEE 62 NEW MODELS
New FEATURES!
New LOW PRICES!

See THEM IN ALLIED'S NEW CATALOG

Dealers! See the sensational new value-giving Knight Radios in ALLIED'S giant 1939 Catalog! 62 new models with new advanced features, new beauty, finer tone, and better performance—as low as \$6.95! 4 to 16 tube models—new "Tiny Knights", new low-drain 1½ volt battery sets, new push-button models, new AC, AC-DC, 32 volt, and auto receivers—all backed by Radio's Strongest Guarantee! See the money-making Knight phono-radios, phonographs, and record players—all priced remarkably low to bring you greater savings and bigger profits. Also, Radio's Most Complete range of Test Equipment, P.A. Systems, Amateur Gear, Build-Your-Own Kits, radio parts for every repairing or building purpose, tools, books, etc. You'll save more and profit more with ALLIED'S 1939 Catalog—send for it!

Save NOW.. Profit NOW
ON EVERYTHING IN RADIO
 Lowest Prices.. Buy NOW from
ALLIED'S 180 PAGE 1939 CATALOG!

NEW PUBLIC ADDRESS—Sound Men! See new line of Knight P.A. Systems—16 to 63 watt standard and deluxe units, New 30 watt Music Systems, Electric Guitar, New 30 watt Master Power Amp—P.A. system for every need. Also the most complete line of recording equipment in any catalog!

NEW HAM GEAR—Amateurs! ALLIED'S 1939 Ham section, an "Amateur's Paradise" includes the new Hallcrafters' "PT" Catalog in Giant Hamlets, and the new National and National Hamlets, "30 Streamliner," and "Martino" and 450 receivers, etc. Howard 400, 410.

NEW RADIO BUILDERS' KITS—100 radio-building diagrams and projects in ALLIED'S 1939 Catalog! Includes: Hardest selection, including Reckoners' Kits, Auto set, Photo Coll Kit, Electric Fence Controllers, and many others!

NEW TESTERS—All leading 1939 Test equipment lines are shown in ALLIED'S 1939 Catalog. New Tester's Alignment, Tube Checker, Push-button equipment, oscillographs, and thousands of exact duplicate and replacement parts!

SEND FOR FREE CATALOG

ALLIED Radio

ALLIED Radio Corp.,
 Dept. 2-L-9, 833 W. Jackson Blvd., Chicago, Ill.
 Send me your new 1939 Catalog—Free.

NAME

ADDRESS

CITY STATE

Be a RADIO EXPERT—Learn AT HOME

RADIO SPECIALISTS NEEDED
 Modern receivers with their complicated circuit systems have knocked out the old time cut-and-try radio fixer. Trained men with up-to-the-minute knowledge are needed to service these new sets.

HERE IS YOUR OPPORTUNITY
 Your possibilities of making money and getting ahead are limited only by your ability and skill—but you must know more than the other fellow. You must be a radio service specialist, as R.T.A. can train you.

FREE OF EXTRA COST

PRACTICAL TRAINING AT HOME
 Our home study course is practical "shop and bench" training combined with a thorough set of practical lessons prepared by an experienced Radio service engineer. Four working outfits are also furnished.

MAKE SPARE TIME MONEY
 Our training is complete and practical. We show you how to make money almost from the start. The course can easily be made to pay its own way. Investigate now, write for free book of details.

WHAT R.T.A. STUDENTS SAY

Norwood, Ohio
 I have connected with a large firm as Radio Service Manager and wish to extend my thanks for your help.
 Joseph Rablen, Jr.

Yorkville, Ohio
 From Aug. 1 to Dec. 7, 1938, I repaired 163 radios and put up 43 aerials which is very good for part time work while studying your course.
 Chas. Koerlier.

RADIO TRAINING ASS'N OF AMERICA
 Dept RC-118, 4525 RAVENSWOOD AVE., CHICAGO

Please Say That You Saw It in RADIO-CRAFT

MONEY SAVERS

MIDGET 6.3 VOLT POWER X'FORMER

For 4 and 5 tube sets. Delivers 580 v. ct. at 50 ma; 5 v. at 2 amps. and 6.3 v. at 2 amps. Primary for 115 v., 60 cycles A.C. 3 1/8" high, 1/2" deep.



54c

MAIL THE COUPON AND SAVE

CONDENSER BUYS

8-8 MFD.
280-380 V.
5-5 MFD.
40 VOLTS



Complete dry electrolytic filter and by pass block. 8 mfd. at 380 v. peak, 8 mfd. at 280 v. peak, 5-5 mfd. at 40 v. peak. Coded leads, with flange. 4 1/2 x 1 3/4 x 1 1/8".

K 672—Your Cost Each.....10c

INVERTED WET ELECTROLYTICS

Round aluminum cans 1 1/2" high by 1 1/8" diameter with walnut for mounting. Can is negative. Limited quantity.

Stock No.	Cap. Mfd.	Wkg. Volts	Each
K 709	30	125	9c
K 710	16	320	14c
K 712	8	375	12c

MAIL THE COUPON AND SAVE

LAFAYETTE 5 TUBE MODEL C-39



Radio triumph of the year is this 1939 Lafayette. A "midget" model, with cabinet of smartly molded plastic, its five

hi-efficiency tubes give your 7 tube performance. Lafayette Model C-39 is truly a standout buy. A few features: Automatic Volume Control, new Wave Trap, illuminated Clock Dial. Full story in our FREE catalog.

FREE CATALOG

The catalog that has everything in radio. You save on everything you buy. You have more than 50,000 items to choose from. You get value far beyond price. Send for your FREE copy of our catalog today.



WHOLESALE RADIO SERVICE CO. INC.

NEW YORK, N.Y. • CHICAGO, ILL. • ATLANTA, GA.
100 SIXTH AVENUE 401 W. JACKSON BLVD. 345 PEACHTREE STREET
BOSTON, MASS. • BRONX, N.Y. • NEWARK, N.J. • JAMAICA, L.I.

WHOLESALE RADIO SERVICE CO., INC.
100 SIXTH AVENUE, NEW YORK, N. Y.

Rush FREE 1939 Radio Catalog No. 73-3LA

Name.....
Address.....
City..... State.....

PASTE COUPON ON PENNY POST CARD

ELECTRONIC ORGAN HELPS DIT-DAH BOYS!

(Continued from page 272)

An ordinary telegraph message is sent over a telegraph wire by interrupting the electrical current on that wire in accordance with a code. Carrier telegraphy differs from wire telegraphy in that a musical tone is transmitted over the line wires and is interrupted in accordance with a code. Fortunately there are available tuning devices which make it possible to separate each musical tone from others, so we may place many such tones on the same line wires, transmitting them simultaneously and separating them at the receiving end by suitable tuning. These tones are the carrier frequencies.

It is astonishing to realize the number of such separate tones which may be placed on the same wires. Thus far but 10 simultaneously have been used, but 50 or more can be added when the volume of traffic requires such an enormous capacity, each tone being a little higher up the scale, the highest tone being far beyond the range of the human ear. Since the traffic of an entire multiplex automatic telegraph system (with 8 telegrams being transmitted simultaneously on each), is placed upon each of these tone systems, the original carrying capacity of the present telegraph wires thus may be multiplied by the hundreds.

"ELECTRONIC ORGAN" TELEGRAPHY

To furnish the numerous pitches or tones for the carrier system, the engineers found it convenient to make use of the same equipment that is used to generate the musical tones in the Hammond Electric Organ. In the organ the key which is A above middle C on the keyboard, as an example, produces a frequency of 440 cycles, that is, 440 vibrations in each second, and produces that note from a tone cabinet. Each other key produces a tone of another frequency.

For the carrier system the engineers found that by choosing pitches 300 cycles apart they could readily put 22 on a single circuit. But each of these pitches can carry a number of messages by methods previously used by Western Union, with the

result that a total of 96 messages in one direction is made possible. Twelve of the 22 frequencies are now in use, and the others may be placed in use at any time to take care of future business growth.

The pitches now available for use start at 450 cycles and go up to 6,750 cycles, with a gap of 300 cycles between each. Messages are transmitted on each of these levels at the same time, and at the receiving end the messages are separated by "tuners", each of which responds only to one pitch or frequency. This system represents the latest development in what for some time has been known to communication engineers as a Voice-Frequency Carrier System but with lower message capacity.

The audibility of the frequency has no bearing upon its usefulness for communication purposes. Development work, however, has already started on equipment to extend the range to above-audible frequencies.

To demonstrate how the organ tone generator functions in a system which more than doubles the capacity of telegraph wires, Western Union engineers had a regular Hammond organ console installed adjacent to a bank of carrier channel equipment where the organ generator is introduced into the system.

"TONE DETECTIVE"

Another feature was a "tone detective," which, by a series of lights placed on clefs of the musical scale, showed the frequencies of the tones produced on the organ, and the tones being used at any time by the generator in the carrier channel system. When Virginia Oman, concert organist, played the instrument, the "tone detective" followed the corresponding lights without any wired connection whatever between the two.

By extension of the carrier system it will be possible for Western Union to provide for growth in telegraph business during many years over existing inter-city wires.

The system provides a vast new field for expansion of telegraph facilities.

NEW CIRCUITS IN MODERN RADIO RECEIVERS

(Continued from page 285)

Each section of this filter cuts the audio output of the 1st R.F. 6R7 down by a considerable percentage and their combined effect is to eliminate the 10 kc. signal.

(5) ELIMINATES TUNING EYE FOR HIGH-FIDELITY

Emerson Models D136LW, D139LW, D140LW, D142LW and D146LW. When a set is capable of covering a high-fidelity band properly with its tuning characteristics, the tuning eye is no longer a satisfactory index of the proper tuning, so it is switched out of the circuit.

High-fidelity characteristics of a receiver circuit enable it to receive a practically uniform signal, sometimes up to 18 or 20 kc. total range. Thus, if the set were tuned to either edge of this total band, it would show essentially the same indication as though it were tuned to resonance. The tuning eye would, therefore, actually be misleading as an index of resonance. This circuit, as in Fig. 2C, provides for switching out the grid of the tuning eye as part of the switching to high-fidelity. The circuit may be more accurately tuned by ear in the high-fidelity position.

TUBES FOR 1939!

December RADIO-CRAFT — on newsstands Nov. 1 — will contain first-release data on new tubes for 1939! Additional information on new tubes will help introduce the special NEW RADIO TUBES Number of "R.-C."

RESERVE YOUR COPY TODAY

YOUR FUTURE IN RADIO TELEVISION

These growing industries need trained men for sales, service, operation. Your chance for employment and advancement depends on thorough training. National Schools offer you time-tested training. Complete, modern facilities and equipment in the largest trade school in the West.

Send for free booklet that shows how you can prepare for these opportunities.



NATIONAL SCHOOLS
4000 S. Figueroa Street, Los Angeles

NATIONAL SCHOOLS, Dept. RC11, Los Angeles
Please send free Radio and Television Booklet.

NAME..... AGE.....
ADDRESS.....
CITY..... STATE.....

Please Say That You Saw It in RADIO-CRAFT

THE LATEST RADIO EQUIPMENT

(Continued from page 288)

iron. This tool is now made available in a form no larger than a fountain pen. By simply pressing the steel point of the "pen" to the part to be oiled, approximately 1/10 of a drop of oil is ejected. If more oil is required repeated pressings of the steel point to the spot will eject the proper amount of oil. Thus no oil is wasted and no part is overoiled. Its many uses include the oiling of variable condenser bearings, tube prongs, button-tuning mechanisms as well as many non-radio items. Clips to the breast-pocket like a fountain pen. Easily refilled. Hundreds of uses; a slick item for Servicemen-dealers.

OSCILLATOR-DOUBLER FOUNDATION HAM-RADIO UNIT (1691)

(The Hammarlund Mfg. Co., Inc.)

CONTINUING its series of "foundation" units Hammarlund now brings to the amateur fraternity a combination oscillator-doubler. These units are so designed that the amateur, no matter how inexperienced, can build a rig with that "commercial" appearance; pre-assembly makes wiring easy and assures proper placement of parts. Although this crystal oscillator-doubler unit (model OD-10) is intended for use with the other foundation units (described in this department in the July and October 1938 issues), it can also be used as a beginners' transmitter with output up to 25 watts on 2 bands with a single crystal.

Together, these 3 units constitute a 300-W. all-band transmitter of modern design. The schematic circuit for this unit will be found at the end of this department; any suitable pentode or tetrode, depending upon output desired, may be used. Note, in photo, the novel cathode-coil unit at left; the crystal plugs into a socket at top.

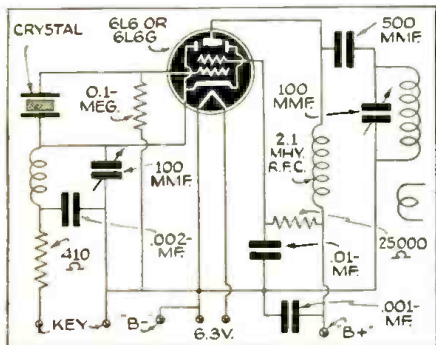

Circuit diagram of the oscillator-doubler.

TELEVISION— POPS ON & OFF AIR!

(Continued from page 270)

transmitter W2XBS in the Empire State tower, and operating on 46.5 megacycles for "picture" signals and 49.75 megacycles for associated sound. This is the only television station in New York City, points out N.B.C.

A temporary antenna on the North side of the Empire State tower was scheduled to be used pending replacement of the permanent antenna on the top of the building by a new array.

Servicemen! Servicemen!
Build the "Super-Geno-Scope"! See December Radio-Craft for detailed description and data!

Here is YOUR RADIO Education!

Every phase of Radio, Electricity, Television, Sound and Cathode-Ray Tubes made crystal-clear by A. A. Ghirardi in his fascinating, readable style. Never before has profitable radio study been such a delightful pastime.

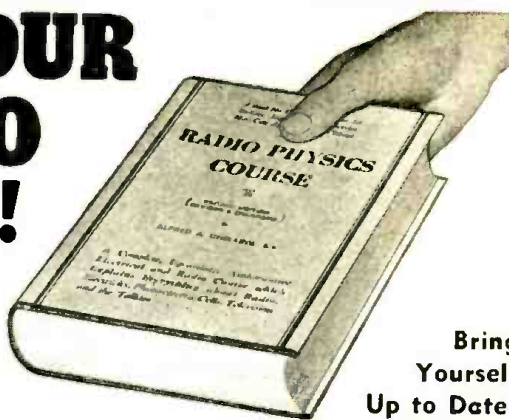

Bring Yourself Up to Date!

Complete Radio Physics Course in one handy volume

Your Big Chance At This Low Price! **\$4.00** Now Only **4** No Further Payments

YOU need no longer be held back from a radio career because you could not spend the time or money to take a course in radio and electricity. You need not stay back in a hum-drum bore-some job because you lack the background for the good position just ahead! Here, in a single volume, is all you missed—and more. Here are the essentials demanded of every radio technician by modern broadcast stations, radio service organizations, manufacturers, sound-film studios, etc. Never before has profitable radio study been such a delightful pastime!

Ghirardi's Radio Physics Course is as easy to read as your daily newspaper. A few minutes a day spent with this amazing volume will quickly transform you into a well-trained radio man. Prepare yourself for advancement, more money, a congenial occupation, a satisfying profession and the respect of your friends by this simple means which is sheer pleasure, more fun than balganes or movies.

Many So-Called "Experts" Do Not Know Half That Is In This Fascinating Volume

Radio Physics Course is a miracle of condensation. Thirty-six volumes packed into 972 pages, complete with review questions for self-study, 508 helpful illustrations, with schematic diagrams, charts, photos, etc. Never before have the basic facts about Sound, Speech and Music been so clearly and usefully presented. Never before have the fundamental principles of electricity been so easy to master and so practical to use. No knowledge of mathematics is required, nor does it matter whether or not you have had any previous electrical training. This great book was written especially to teach you radio in your own home.

The whole science of radio unfolds before you, from elementary theory right up through the latest developments and applications. In sound pictures and graphic diagrams so vivid you cannot ever forget them. The story of Television becomes a living drama, with its technical problems so clearly set forth you will understand them better than do many of the "old-timers." The intricacies of Cathode-ray Tubes and Photoelectric Cells are explained away so simply you will wonder how they could ever puzzle you. The facts about Public Address Systems, Sound Motion Pictures, Phonograph Pickups become tools in your hands, tools with which to work in building your future in the coming specialized profession of Sound Engineering.

Testing and Servicing: Automobile, Aircraft and Marine Radio; Short-Wave Reception; and Invaluable Appendices complete this huge, comprehensive Radio Course, making it the greatest bargain in radio education of all time! That's why it's used and praised by more radio schools and students than any other radio book in the world. It's complete! It's concise! It's easy! It's authoritative!

10-DAY TRIAL

We want you to see this book. We want you to judge for yourself, in your own home and at your

Fill in the gaps in your RADIO EDUCATION — Get Yourself a Solid Foundation!

36 Volumes in 1

1. Radio Broadcasting System.
2. Sound, Speech and Music as related to Broadcasting.
3. Electron Theory.
4. Electrical Units, Ohm's Law, Resistance.
5. Electrical Circuits, Batteries.
6. Magnetism.
7. Electromagnetism.
8. Electromagnetic Induction.
9. Inductance and Inductors.
10. Capacitance and Condensers.
11. Alternating Current Circuits.
12. Electric Filters.
13. Electrical Measuring Instruments.
14. Electromagnetic Radiations.
15. Radio Transmission, the Broadcasting System.
16. The Receiving Station, Detection with Crystals.
17. Elementary Study of the Vacuum Tube.
18. Vacuum Tube Characteristics.
19. Construction Features of Vacuum Tubes.
20. Vacuum Tube Detector and Amplifier Action.
21. Radio Frequency Amplification.
22. Superheterodyne Receivers.
23. Design of R.F. Amplifiers and Tuning Coils.
24. Audio Amplification.
25. Loud Speakers.
26. The Superheterodyne Receiver.
27. The Power Supply Unit.
28. Electric Receivers.
29. Automobile and Aircraft Receivers.
30. Phonograph Pickups and Sound Amplifier Systems.
31. Short-Wave Reception.
32. Vacuum Tube Applications and Photoelectric Cells.
33. Television.
34. The Antenna and Ground.
35. Testing and Servicing.
36. Sound Motion Pictures.

972 pages check-full of "meaty" information, 508 graphic illustrations, 856 Review Questions, make self-study easy!

leisure, just how much it can mean to you. Fill out the coupon below and mail it at once. Ghirardi's Radio Physics Course will be sent you by return mail. Examine the fine binding, the large, clear type; take your first Radio lessons and check yourself on the knowledge you gain. Keep and read the book ten days—then decide if you wish to own it at the amazing price of only \$1, postage prepaid.

Money-Back Guarantee — ACT NOW!

If, after reading and examining Radio Physics Course, you are not thoroughly satisfied in every way, return the book in good condition within the 10-day trial period, and every penny of your money will be immediately refunded. You see you cannot lose! So send the coupon without delay. This is the greatest opportunity ever offered you for a complete radio education at this astounding price. You couldn't do better anywhere. Don't pass up your one big chance to get inside "the profession with a future." It all depends on what you do about that little coupon below. FILL IT OUT! MAIL IT. AT ONCE!

MAIL THIS COUPON TODAY

Radio & Technical Publishing Co.,
45 Astor Place, Dept. RC-118,
New York, N. Y.

Books Sent Postpaid Anywhere!

Enclosed find \$4. for my copy of Radio Physics Course, by Alfred A. Ghirardi. (84.50 foreign). If not fully satisfied, I have the right to return the book, undamaged, within 10 days and get my money refunded at once.

NAME

STREET

CITY STATE

Please send me free descriptive literature about Radio Physics Course.

A Sure-Profit Field for Alert Radio Men!

HOME RADIO DIATHERMY

Hundreds of Radio Servicemen are now representing our Home Short wave diathermy line and acting as our agents in all parts of the country. We offer exclusive territory with absolute protection for all agents accepted by us. Our Short wave diathermy line is standard and has been definitely accepted as "fool-proof" by all who have made the most rigid tests possible on Diathermy equipment.

Our agents have averaged better than \$40.00 a week part-time. Full-time agents can easily do better. We show you how! Write for full particulars and details on making a real good income.

SCIENTIFIC DIATHERMY CORP.

200 W. 34 St., Dept. RC, New York, N. Y.

SOLAR

MINICAP

Newest development in Electrolytic Capacitors

Catalog upon request

SOLAR MFG. CORP. 599-601 Broadway, New York

"Take it Away-



Centralab
THE NEW
**Low Capacity
LEVER ACTION
SWITCH**

for any application where multiple contact, low capacity switches are required to operate at low voltages and currents.

- BROADCASTING . . . In control panels for commercial and amateur transmitters.
- RADIO RECEIVING . . . Band changing, I.F. selectivity, sensitivity, tone, and similar controls.
- PUBLIC ADDRESS . . . Centralized sound, intercommunicator, call systems.
- TEST INSTRUMENTS . . . Signal generators, analyzers, tube testers, multi-meters.
- INDUSTRIAL USE . . . Electronic apparatus, signaling devices, business machines.

Centralab Lever Action Switches are furnished with either two or three positions. Index action can be positive in all positions, or spring return to center from either side.

Send for specification sheet number 628, giving further electrical and mechanical details.

Centralab
MILWAUKEE WISCONSIN

WIRE-LESS PUBLIC TELEPHONES ON WHEELS!

(Continued from page 272)

the convenience of newspaper reporters and others in the throng gathered to welcome the fliers.

The public telephones were in addition to 47 press telephone lines, telephoto, radio and telegraph circuits installed by the company to help news, radio and camera men flash the news of Hughes' arrival to the world.

The truck on which the booths were installed at Floyd Bennett Field is one of those used regularly to transport telephone booths for installation on Long Island. Connections to central office facilities were made by splicing into a nearby cable.

This arrangement was used once before, when the Italian "Good Will" fliers, under the direction of General Italo Balbo, landed at Floyd Bennett Field in July, 1933. It has proved such a convenience to the public that the telephone company plans to continue its use as the occasion arises.

PAY-TELEPHONE TRAILERS

What is believed to be the first "telephone booth trailer" is being used in Maryland by the Chesapeake & Potomac Telephone Company at public gatherings of various types. It was designed to meet the need for adequate telephone facilities at football games, fairs, field meetings, sports events, etc. See illustrations B and C.

The trailer is equipped with 5 comfortable and attractive telephone booths, in each of which is installed a cradle-type handset.

Immediately to the right upon entering the trailer is the desk of the attendant who places and times all calls and collects the charges for them. After the customer has given his request to the attendant and the connection has been completed, he is assigned to an idle booth where he can converse with the called party in privacy. If he wishes to make additional calls, he can do so without leaving the booth. This is made possible by an intercommunicating circuit between the booth and the attendant.

In planning the trailer every effort was made to provide comfort and convenience for the customer in using the telephone. Each booth is equipped with an upholstered seat, an electric fan and a heater; the outer room is provided with a comfortable bench for waiting customers. Mahogany walls and chrome fixtures add color to the interior of the trailer.

All Maryland telephone directories, as well as those of frequently called cities outside of the state, are a part of the trailer's accessories.

The exterior of the trailer, which is 21 feet long, is in blue with gold lettering, the roof being finished in aluminum. Just above the entrance is a neon-illuminated sign, "Public Telephones," which is visible from a considerable distance.

In planning the equipment it was necessary to make provisions for its use in all localities of Maryland, whether the local equipment is magneto, common battery or dial. The result was a specially-designed attendant's cabinet consisting of a group of keys which control ringing, supervision, holding, inter-communication between the attendant and the customer, and other operations.

During the Baltimore automobile show approximately 800 calls were made from the trailer; 4,500 persons stopped to inspect or inquire about the equipment and more than 1,500 made some favorable comment.

PUBLIC RADIOPHONE MOBILE UNITS

Readers of *Radio-Craft* magazine are

Westinghouse Power Generator

Manufactured for U. S. Signal Corps 200 Watt 110 V. AC

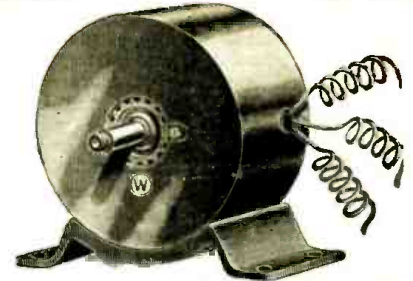

A. C. ELECTRICAL POWER

from a Windmill, from available Waterpower, from your Automobile, from your Motorcycle, from your Bicycle, Foot-pedals or Handcrank (for transportable Radio Transmitters, Strong Floodlights, Advertising Signs); do you want to operate AC Radio sets from 32 V. DC farm light systems; operate two generators in series to get 200 V. AC; obtain two phase and three phase AC, etc., etc.

There Are Over 25 Applications

Some of which are:

A.C. Dynamo lighting from eight to ten 20 Watt 110 Volt lamps. Short Wave Transmitter supplying 110 Volts AC for operating "Ham" transmitter. Operating 110 V. AC 60 Cycle Radio Receiver in DW districts. Motor Generator. Public Address Systems. Electric Sirens on motor boats, yachts, etc. Camp Lighting. Short Wave artificial "fever" apparatus. Television. Pelton Waterwheel for lighting or other purposes. Airplane: for lighting strong searchlights or electric signs. Laboratory work, etc., etc. 1/4 to 1/2 H.P. needed to run generator.

BLUE-PRINT 22 x 28 in. and Four-Page 8 1/2 x 12 in. INSTRUCTION SHEETS FREE with Generator.

Generator, as described, including four replacement carbon brushes, Blue-Print and instructions **\$7.90**

Send \$2.00 deposit, balance C.O.D.

Shipping weight 18 lbs. (Replacement carbon brushes bought separate \$1.50 per set of four. Set of instructions bought separate \$1.00.) MONEY-BACK GUARANTEE

WELLWORTH TRADING COMPANY

560 West Washington Blvd., Dept. RC-11-38, Chicago, Ill.

FREE *..tells how to* **SAVE MONEY**
ON EVERYTHING YOU BUY!



FREE *..tells how to* **SAVE MONEY**
ON EVERYTHING YOU BUY!

NOW READY—big new Bargain Bulletin. Describes, pictures hundreds of amazing values. Tell us where to RUSH your FREE COPY:

You can save many Dollars on your purchases out of this new Bargain Bulletin—on Radio Sets and Parts, Sporting Goods, Watches, Clocks, Cameras, Typewriters, Electrical Specialties, Novelties, and scores of other articles. Thousands of smart buyers have discovered this sure way to save money on standard, highest quality merchandise. You get prompt, courteous service, complete reliability. Get **100%** of big savings—take your pick of the amazing values shown in all your present needs.

YOUR FREE BARGAIN BULLETIN IS WAITING

Fill in and mail NOW the coupon below—or send postal or letter. No obligation. Some bargain offers limited—rush your request while stocks are at their best.

RADIO CIRCULAR CO., Inc.
915 Broadway (Dept. R.C.), New York, N. Y.

MAIL THIS COUPON NOW

RADIO CIRCULAR CO., Inc. (Dept. RC)
Yes, rush my Free Bargain Bulletin.
No obligation to me

NAME _____

ST. & NO. _____

CITY & STATE _____

SERVICE MEN AND DEALERS

Send for new 12-page circular describing 1939 line of service equipment and parts. (Largest part store in New York.)

TRY-MO RADIO COMPANY, INC.
85R CORTLANDT STREET, NEW YORK, N. Y.



FOR THE RADIO SERVICE MAN, DEALER AND OWNER

The man who enrolls for an I. C. S. Radio Course learns radio thoroughly, completely, practically. When he earns his diploma, he will KNOW radio. We are not content merely to teach the principles of radio, we want to show our students how to apply that training in practical, every-day, radio service work. We train them to be successful!

INTERNATIONAL CORRESPONDENCE SCHOOLS

Box 6675-E, Scranton, Penna.
Explain fully about your course in the subject marked X:

- RADIO
- EXPERIMENTAL TELEVISION
- SOUND TECHNICIANS
- AVIATION SECTION OF RADIO OPERATING

Name _____ Age _____
Address _____

**A Scoop by Superior!!
D.C. VOLT-OHM MILLIAMMETER**

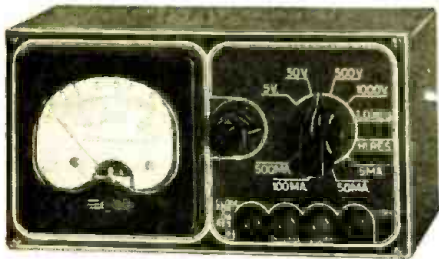

A sensationally low priced new pocket-size volt-ohm milliammeter. Features a 3" d'Arsonval type 0-1 meter, accurate within 2% ; precision resistors. No external batteries necessary. Neat aluminum etched panel.

SPECIFICATIONS

0-5 volts D.C.	0-5 ma. D.C.
0-50 volts D.C.	0-50 ma. D.C.
0-500 volts D.C.	0-100 ma. D.C.
0-1000 volts D.C.	0-500 ma. D.C.
0-500 ohms	0-500,000 ohms

Model 1100-S supplied with batteries, test leads and instructions. Size 6 1/2" x 3 1/2" x 2 1/2"; shipping weight 4 1/2 lbs. Our net price....

\$5.85

SUPERIOR INSTRUMENTS COMPANY

136 LIBERTY ST., DEPT. RC-11 NEW YORK, N. Y.

FREE TRIAL OFFER

NEW REMINGTON NOISELESS PORTABLE!

AS LITTLE AS

**10¢
A DAY**



Famous Remington Noiseless Portable that speaks in a whisper. Pay as little as 10¢ a day. Guaranteed by the factory. Standard keyboard. Automatic ribbon reverse. Variable line spacer and all the conveniences of the finest portable ever built. PLUS the NOISELESS feature. Act now. Send coupon TODAY for details.

You don't RISK a Penny

We send you Remington Noiseless Portable for 10 days' free trial. If not satisfied, send it back. We pay all shipping charges.

Typing Course and Carrying Case

You will receive FREE a complete simplified home course in Touch Typing, a handsome sturdy carrying case is included. No obligation. Mail coupon for full details—NOW.

Remington Rand, Inc., Dept. 189-11,
465 Washington St., Buffalo, N. Y.

Tell me, without obligation, how to get a Free Trial of a new Remington Noiseless Portable, including Carrying Case and Free Typing Course for as little as 10¢ a day. Send Catalogue.

Name
Address
City State

PHONOGRAPH RECORDS

12-DECCA, BLUEBIRD or VOCALION records-\$1.00
8-VICTOR, COLUMBIA or BRUNSWICK records-\$1.00

Each record is the standard 10" and plays both sides. Hot dance numbers, vocal instrumental, waltzes, old timers, cowboy, hill billy, etc.
All popular artists. Hurry while they last. No C.O.D.'s.

Write for New Radio and Phonograph Catalog
UNITED RADIO COMPANY
158-P Market Street, Newark, N. J.

WHY PAY MORE?

ALL TUBES GUARANTEED			
1V	\$.25	25Z5	\$.30
6C6	.30	27	.25
6E5	.35	35	.25
22	.35	45	.20
		201A	.30

WRITE FOR COMPLETE PRICE LIST
NEW YORK RADIO SUPPLY CO.
152 West 42nd Street New York, N. Y.

OVER THIRTY BIG OFFERS!

The Classified Advertising Section which appears on Page 316 of this issue contains many interesting offers and services. TURN TO IT NOW... READ IT FROM START TO FINISH.

familiar with Western Electric dial telephone radio equipment now being installed on tugs, tenders, yachts and small-boats to afford local and long-distance communication over the regular Bell Telephone land lines. It is but a step from employing this equipment on board a boat to setting it up in a truck, and thus making dial telephone service available by radio wherever normal telephone facilities may be unexpectedly overtaxed; as described above in connection with the application of the mobile telephone trucks that at present are limited in operation to localities which will permit a cable connection to be run-in from the truck or trailer to a nearby telephone outlet.

Several antennas may be required to permit simultaneous 2-way conversation between more than one couple. One antenna, however, as described in past issues of "R.-C.," may be used for simultaneous 2-way conversation between 2 people.

Of course, it would be necessary to set up permanent posts or stations for maintaining contact with the mobile units, but many such stations of nearly the requisite design are already in use, on both U. S. coasts and the Great Lakes vicinity, in the previously-mentioned maritime service; and, perhaps, could be utilized to meet land needs in emergencies or on special occasions.

Anyway, it's a forward-looking idea that does not seem to present insurmountable difficulties. In fact, from an experimental standpoint, available means are adequate for putting the radio mobile telephone pay-station system into operation tomorrow.

**CASH-IN ON YOUR
RADIO EDUCATION**

(Continued from page 265-266)

V. E. JENKINS (Continued)

house when lacking saws, hammers, etc. Likewise, knowledge alone will not service a radio set. Education with the proper testing equipment is the unbeatable combination.

Be judicious in the selection of equipment. Make every dollar expended return a dollar's worth of value. Fundamental test apparatus with practically unlimited life represents the utmost in dollar value. Money saved buying the right equipment is money earned for your business.

The rapid-moving radio picture sees the introduction of a host of servicing methods. By means of romantic merchandising ideas woven around each method. Servicemen are oftentimes led to purchase useless equipment. Don't complicate your methods of servicing by trying to master every new technique introduced. Education is always in terms of fundamentals and there is no substitute for them in test equipment.

Manufacturers of test equipment as a whole are sincere in trying to produce thorough, yet simple, equipment. However, the rapid pace of the radio industry has resulted in some manufacturers producing equipment of doubtful nature as far as the entire servicing industry is concerned. Testing by means of unconventional, passing methods must of necessity result in a mass of test equipment whose cash value or earning power to the servicing industry is low.

The wise Serviceman, who wants to keep his business paying dividends, will build that business on the basis of using fundamental test units.

HOME TALKIES!

Read December Radio-Craft for "How to Make" Articles

A CHAMPIONSHIP NINE

RIDER MANUALS

Now in **9** VOLUMES

It takes nine men to make a championship baseball team

And in radio it takes all NINE Rider Manuals to make a "big league" outfit of a radio servicing business. The New Rider Manual Vol. IX will hurl you right into the money class. This great Manual gives you 1650 pages of the most complete and authentic compilation of servicing data available in the industry. Thousands of facts and easy-to-understand diagrams and explanations are given, plus an entirely new, 64-page "How It Works" Section—the most "talked of" feature of Vol. VIII. There is also a 140-page easy-find index on all NINE Volumes, now containing a total of 11,270 pages. You need the new Rider Manual Vol. IX with all its extra features.

Place your order with your jobber today.

JOHN F. RIDER, Publisher
404 Fourth Ave., New York City

VOLUME IX
Out Nov. 19th
1650 Pages
New "How It Works" Section
140-page Index



DID YOU SAY 9?

YOU NEED ALL 9 Rider MANUALS

YES, I SAID 9!

Please Say That You Saw It in RADIO-CRAFT

RADIO TRADE DIGEST

**QUICK, EASY MEASUREMENTS—
SENSATIONAL HICKOK "JUMBO"
WITH OHM MILLIAMMETER
with 9" METER**



WIDE COVERAGE—AC—DC Volts, DC Microamperes, D.C. Milliamperes, Resistance, Decibels, Output, Highly sensitive movement, Scale over 7" long, easily read from any angle. Rugged, HICKOK built thruout. Exceptionally low price for high quality instrument.

Mail coupon for full information.

**HICKOK ELECTRICAL INSTRUMENT CO.,
CLEVELAND, OHIO**

HICKOK ELEC. INSTRUMENT CO.,
10401 Dupont Ave., Cleveland, Ohio

Gentlemen: Send information on "Jumbo"
Volt Ohm Milliammeter.

Name

Address

City & State

**\$50, \$75, \$100 A WEEK
IN TELEVISION?
Yes It's NOW Being Done!**

Big money is being earned in Television right NOW, TODAY! We can PROVE this! Get your share! Television offers you a fascinating, new, uncrowded field, with unlimited money-making opportunities. Don't be one of those who will say, "I wish I had." ACT NOW!

TELEVISION IS ON THE AIR!

Already there are 18 Telecasting Stations in America. Programs are being broadcast. Television Receivers are on sale. Tremendous progress has been made. The above facts are definite indications that TELEVISION HAS ARRIVED! Now is the time to get in on the ground floor! Train for your future in Television in which you may earn \$1500 to \$7500 a year. . . . A.T.I. is now training more men for Television than any other organization of its kind. A complete Television Receiver and Transmitter included with your training at NO EXTRA COST.

SEND COUPON FOR FREE DETAILS!

We want to put the "Evidence" right in your hands. It costs you nothing to investigate. This may be the turning point in your life. "Get out of that rut." Get into Television!

AMERICAN TELEVISION INSTITUTE

433 E. Erie St., Chicago, Illinois, RC1138

Gentlemen: Please send me your Television book, literature, and complete details. It is understood that all this is free. No obligation. Nothing to pay.

Name

Age

Street

City

State

BUILDING FOR A BOOM— IS TELLY THE ANSWER?

(Continued from page 289)

while 3% stated that it was helping sell radio sets right now. But the largest number (51.4%) believe it has little or no effect on present business.

The response to the query as to whether the actual arrival of commercial television would help or harm biz was more along expected lines. No less than 72% of the trade replying thought that television would cause a boom in radio, while 15.6% believed that it would be of little, if any, advantage to the trade. Only 12.4% thought that it would retard the radio business. A few of the unresponsive replies, not considered in figuring percentages, stated their writers' belief that real television would not arrive "in our lifetime."

Prices at which television sets should sell well to the public, while allowing a reasonable profit, were set everywhere from \$25 to \$500. These prices were arbitrarily divided into 3 groups. 34.5% of the replies put a maximum price of \$100 on a good television receiver; 55.2% priced television receivers between \$100 and \$200, while the remaining 10.3% figured that a good set could not be sold under \$201.

And what does the trade expect television to produce? All answers indicated that pictures must be bright, clear, detailed, and free from flicker. The size believed adequate ranged from 4 x 4 in. to 3 x 4 ft. The following tabulation shows the breakdown:—

5 x 7" or less	6.5%
5 x 7 to 8 x 10" (inc.)	36.5%
8 x 10 to 11 x 14" (inc.)	24.2%
11 x 14 to 18 x 24" (inc.)	26.2%
18 x 24 to 36 x 48"	6.6%

From the foregoing, it would appear that a picture about 11 x 14 ins., good in every respect, and produced by a receiver selling at \$100 is the trade's ideal of television. There is no question but that it would bring about a boom comparable to that experienced in the early '20s. But is it commercially possible?

The answer still lies in the laboratories. (NEXT MONTH: Startling opinions on facsimile, by the radio trade. Is its success possible or even probable? Don't miss these answers to the RTD survey.)

PHILCO SECRET MYSTERY CONTROL EXPOSED: KADETTE TO COMPETE

(Continued from page 289)

to any receiver already in use. At press time, no prices or details of the Kadette were available, but it is the opinion of the trade that it would be a red hot seller if its price installed is comparable with that of a midget set.

FCC Still Making Tests

Also at press time, the FCC was preparing to test not only the PMC but also a number of other radio-actuated devices, such as burglar alarms, door openers, etc.

The RTD reporter has seen the PMC and is enthusiastic about its operation, although he had not listened to a set operating on 80 meters while the Philco was being mysteriously tuned. The FCC will, no doubt, make a test of that sort—and if Philco passes it satisfactorily, the "industry leader" quoted in Sept. RTD will be out \$100. Which is more than likely.

PERSONALS

(Continued from page 290)

Robt. ("Corey") Corenthal, former asst. to pres. of Reiss Advtg. Inc., resigned to become adv. mgr. of Terminal Radio Corp., N.Y.C.

Harry F. Mickel, with RCA 12 yrs., succeeds P. A. Anderson (resigned) as Mgr. of the co.'s police radio section.

Personnel of the RMA fact-finding committee on the wage-hr. law includes J. R. Howland, chairman, Phila., R. R. Kane, Camden, N. J., S. T. Thompson, Chi., C. J. Hollatz, Owensboro, Ky., & Octave Blake, Plainfield, N. J.

Roster of Chairmen of RMA Committees:—Dr. W. R. C. Baker, Engineering; V. M. Graham, Standards; L. C. F. Horle, Parts & Safety; H. A. Crossland, Service; E. T. Dickey, Best. Receivers; R. M. Wise, Tubes; H. S. Knowles, Sound Equip.; A. F. Murray, Television; J. H. Pressley, Autoradio; I. J. Kaar, Television Receivers; E. W. Engstrom, Facsimile.

TELEVISION ACTIVITY INCREASES

(Continued from page 292)

Announcement states that course has been commenced because "basic system of television is unlikely to undergo any immediate major change."

New Zworykin Patent

U. S. Pat. No. 2,125,997, assigned to RCA by Dr. Vladimir Zworykin, covers a new system for sending & receiving ultra-short waves between synchronized xmtr & receiver. Fading at receiver causes a shift in the freq. at xmtr, changing angle of reflection of the wave from the Kennelly-Heaviside layer.

This is good for relay stations & similar rebroadcasts; not intended for individual sets.

SNOOPS & SCOOPS

(Continued from page 290)

G-E's electric thermostatic control crib blanket keeps baby warm & should peddle to modern mommas; low voltage makes it ultra-safe, & it's shockproof even if wet . . . NBC signed to pay its 31 sustaining announcers \$110-\$250 a mo. for next 2 yrs. . . . FTC is still working on fair trade rules for set mfrs. . . . Philco's Warranty Labor Service, covering parts & labor on custom-built auto set repairs within 90 days, now covers Fords & Lincolns, too.

Fr. Chas. Coughlin, who was going to keep mum if Lemke got the ax in '36, will be back on the air commencing Nov. 3. . . . Despite reports that MBS is readying an RCA telemitter for fall (Continued on page 310)

HARRY B. LEVY, vice-President and General Manager of the Aeolian Company of Missouri, RCA distributors, died from a sudden heart attack that overtook him as he was walking in the street. Mr. LEVY, who was only 49 years old, has been prominently identified with the music merchandise and radio business for the past 20 years. He was one of the best known and liked men in the industry.

Size of box: 12 1/2" x 8 1/2"

\$2.75

Shipping Wt. 3 lbs.

VOGUE Pyro Pantagraph

With this PYRO PANTAGRAPH turn leisure time into profitable hours. Make money a novel, easy way—"Burn Your Way to Extra Dollars with Pyro Pantagraph." This electrical outfit is especially designed for burning designs permanently on Leather, Wood, Cork, Gouards, Bakelite, etc. Simply plug the Pyro-electric pencil in any 110-volt AC or DC outlet and it is ready to be used. Plug and cord furnished as part of equipment. By the use of a special Pantagraph included in the outfit, any design may be reproduced either in original, reduced or enlarged form. Outfit consists of: one Pyro-electric Pencil; one Pantagraph; three hardwood plaques; one bottle of Varnish; one Brush; one tracing tip and four-page instruction sheet.

Outfit will be forwarded by Express Collect if not sufficient postage included with your order.

WELLWORTH TRADING COMPANY
558 W. WASHINGTON BLVD., Dept. RC-11, Chicago, Ill.

CASH IN ON YOUR SPARE TIME!

300 WAYS TO MAKE MONEY

ONLY **25c** Per Copy

CASH IN!

MAIL ORDER PLANS TESTED MONEY MAKERS BUSINESS SECRETS SUCCESS SCHEMES

25 CENTS

68 PAGES

SOLD ON A MONEY-BACK GUARANTEE!

In "CASH IN" you get ALL the real money-makers—dozens of profitable tested mail order plans, confidential business secrets, dozens of practical tested formulas, successful tested schemes—actual experiences of men who have started on a shoestring—with less than \$10 capital.

Buyers of This Book Tell Us—

"Highest value I've yet to see. Book is worth at least a dollar." S. HUDA, Hicklyn, N. Y.

"Your book is as good if not better than others selling at \$1.00."

GEORGE BRUNET, Montreal, Can.

"CASH IN is the best value I have yet to see in the mail order field."

LAWRENCE FOX, Brooklyn, N. Y.

"CASH IN" contains only tested ideas covering every type of full- or spare-time enterprise—it's a "masterpiece" in business venturing.

25 CENTS per copy. Sent POSTPAID anywhere upon receipt of 25 cents U.S. stamps or coin.

NATIONAL PLANS INSTITUTE
246-R FIFTH AVENUE NEW YORK, N. Y.

LES Correspondence Courses in RADIO and ELECTRICAL ENGINEERING

ELECTRICAL ENGINEERING Get good grasp of wide electrical field. Prepare yourself, at Low Cost, for secure future. Modern, simplified. You can understand quickly.

RADIO ENGINEERING Extra fine course in radio, public address, photo-electric work. Trains you to be super-service man, real vacuum tube technician. Expert kits furnished. Diploma on completion. Tuition, \$25, either course. Deferred payment plan.

FREE Get copies of school catalogs, student magazines, complete details. SEND NOW!

LINCOLN ENGINEERING SCHOOL, Box 931-A10, LINCOLN, NEBR.

CASH-IN ON YOUR RADIO EDUCATION

(Continued from page 267)

LEON L. ADELMAN (Continued)

entering its merchandising field; nor does it allow detailed description of the innumerable ideas that go to make up a catalog, a sales campaign, a follow-through on a new instrument design with a view to determining its possible sales value, and so on. We will, however, gloss over these factors before presenting our conclusions regarding future prospects in radio merchandising. Intelligent application of theoretical knowledge gained in the school room and laboratory, and practical experience gained in radio are an enviable combination to meet entrance requirements. Want a formula for success? . . . here it is: *Work*. It frequently is part of the department head's job to keep the lights burning late in the home-office, seeing to it that every order has been filled. Mostly, though, he is on the road. Air travel speeds the journey; if he is a go-getter, he will prefer to spend his time with customers and sales representatives.

If the radio man has been able to secure editorial experience, it will stand him in good stead when the various forms of printed matter (ads, catalogs, flyers, form letters, etc.) come to his attention. Prior experience in the sales division affords an insight into the problems confronting Servicemen, dealers, jobbers and manufacturers in their ceaseless battle for profits. An apprenticeship as a counter salesman affords first-hand knowledge of the requirements of radio parts buyers and dealers. And, training in a laboratory or as a field Serviceman equips him to know the faults to which radio sets are prone and the importance of quality parts in avoiding service troubles. Having thus acquired some idea of how the "individual" fits into the picture, let us see what is the set-up of the "organization."

Starting from scratch, and having as previously mentioned established a company policy a comprehensive, illustrated catalog of the entire line of products is in order. Flyers, of 1 and 2 pages, then fill the gap between catalog editions. To create a consumer demand a medium having maximum coverage at minimum expense is chosen; direct-mail is usually included in this activity. At about this time distributors and jobbers—eventually these may run into the hundreds—must be lined-up. Counter, window and wall displays now serve to tie-in the preceding steps. Packaging, advertising and merchandising campaigns, the development of promotional ideas, establishing and maintaining ample stocks for prompt delivery, these and many other activities go to make up the lot of the successful radio merchandiser.

From the foregoing outline *Radio-Craft* readers will realize that the growth of the radio merchandising field is limited only by the extent of its engineering development, and that extent seems almost limitless; a new idea today means 10 tomorrow—a hundred the day after. And every one of these ideas demands its own sales set-up in order that it may be brought to the attention of that all-important person, the cash customer.

Right at this moment, things are looking up for the radio beginner who wants to get in on the ground floor; and for the more advanced radio man whose experience assures him of a higher rung in the merchandising ladder. Inventories have been greatly reduced, the seasonal trend is now upward, bank savings are high—all indicia of better days ahead. Radio will reward those who stay with it and apply themselves.

It's Yours—It's FREE

Modell's FIFTIETH ANNIVERSARY CATALOG and BUYERS GUIDE

1939 RADIOS AND ELECTRICAL APPLIANCES

NEW YORK, N.Y. CHICAGO, ILL. ATLANTA, GA.

CHOCK FULL OF HUNDREDS OF STANDARD BRAND PRODUCTS

Our New 1939 50th Anniversary Catalog

Is just coming off the press. It's chock full of new 1939 model **RADIOS**—over 100 of them, many of them illustrated: *Midgets, Consoles, Table models, Chair models, etc.* that sell from \$1 to \$1,050, made by Nationally known manufacturers of standard make radios, such as RCA Victor—Philco—Zenith—Stromberg—Carlson—Emerson—GE—Tosley—Westinghouse and many others. Then there are over 700 other items. **ELECTRIC SPECIALTIES** for the home, such as electric refrigerators, stoves, lamps, vacuum cleaners, electric irons, clocks, toasters, percolators, roasters; electric razors, electric trains, cameras, movie cameras, typewriters, bicycles, &c., &c., &c.

Then we also have a new department—**RECORDS & RECORD PLAYERS**, over 250,000 records, 10-inch double face electrically recorded. Swing numbers, waltzes, dance, vocal, instrumental, hill billy, old-time, sentimental, &c., recorded by some of the best known record artists, at only 12 for \$1, or 25 for \$2, and electric record players for as low as \$7.85. All this is found in our new 1939 catalog.

This **GOLDEN ANNIVERSARY** catalog of 100 pages is really an encyclopedia on Radio and Electric Specialties. It not only gives you an array of wonderful bargains, but it shows you how to make a good income devoting your spare or full time without any experience being necessary or the investment of one penny.

Remember every article we offer is brand new, absolutely perfect, guaranteed and shipped in the original factory sealed carton. As we sell only well known branded merchandise, the manufacturer, who cannot afford to take chances with his reputation, stands back of everything he makes. Therefore you are not taking any risk in buying standard brand merchandise at **MODELL'S**. As Christmas is approaching, you will find many people looking for gifts. The Modell 50th Anniversary catalog is just full of ideas and suggestions for gifts for many occasions.

If you sincerely want a catalog that will show you all the latest Radios and Electric specialties—a catalog that will show you how to make money, mail the coupon below to our nearest branch and we will send you the "1939 Golden Anniversary" catalog.

DO IT TODAY

Modell's

Since 1889

58 Cortlandt St., New York, N. Y.
56 W. Washington St., Chicago, Ill.
57 Forsyth St., Atlanta, Ga.

MODELL'S, Dept. D-16
58 Cortlandt St., New York City, N. Y.

Send me your new 1939 Golden Anniversary combined Radio & Electric catalog No. 112 with agent's commission plan.

NAME

ADDRESS

CITY STATE

PASTE COUPON ON PENNY POSTCARD

DON'T LET SERVICE WORK GET YOUR GOAT!

Equip yourself to MASTER THE JOB—



EVERY service man who is on his toes and who expects to make anything out of service work, needs the backing of Simpson testing equipment. Here are instruments that take all guesswork out of the most complex service jobs. You ought to have the latest information on the many new Simpson developments that are making such a tremendous hit among service men everywhere. We shall be glad to send you the latest Simpson bulletins. Why not write for them?

Simpson Electric Co., 5208 Kinzie St., Chicago

—And now the New 333

Tube Tester—a smaller tube tester built to highest standards of Simpson quality, with a lot of new features, at the remarkably low price of \$26.50. Write for new circular on this amazing little tube tester.



—and the new super all-service, tube and set tester

—the Model 440 "Test-master" There is truly nothing that you can ask for or find in any instrument that is not covered in the Model 440. No other tester selling at any price provides as many tests and ranges! At \$59.00 service men say it's the best buy on the market.



—the smallest "Pocket Type" A. C. and D. C. service Volt-Ohm Milliammeter on the market—the Model 230

At \$14.25 this is an instrument that every service man will want in his kit.



ASK YOUR JOBBER

SIMPSON

Instruments that STAY accurate

SPRAGUE ATOMS

"Mightiest Midgets of All"



SAVE Time... Money. Space!

Actual size of an 8 mfd. 450 V. ATOM. List price only 60c. Others equally low.

Use Sprague ATOM Dry Electrolytic Condensers for those jobs where you've got to save space—where you've got to install a really good, honestly reliable condenser at a rock-bottom

price. ATOMS are made by an exclusive Sprague etched-foil process that guarantees highest quality. No "blow-outs"—not a "firecracker" in a carload!

Made in all standard capacities including DUAL COMBINATIONS. Just the thing for "duplicate" replacements. You save real money—and you get the finest, most dependable midget condensers on the market today. Featured by leading jobbers singly or in handy kits.

Write for Free Catalog



SPRAGUE PRODUCTS CO.
North Adams, Mass.

RADIO TRADE DIGEST

SNOOPS & SCOOPS

(Continued from page 308)

videocasts, WOR says: nix—facsimile only, at present Jensen Radio Mfg. Co., of Chi., has 5 models of 12-inch P.M. spkrs. in its line.

American Standards Assn. has approved standards for electrical indicating instruments in 3 classes: portable, switchboard & lab. Philco-Tropic is trade name for the co.'s export line, which features damp-proofing & good S-W reception. RCA's readying its biggest line of bat. sets (for farms) since AC tubes made debut.

New Fadas with automatic tuning run from \$24 to \$229.50; latter has automatic phonoradio. "Simplified home facsimile" as well as tech features of RCA sets is being described to servicers & dealers in 100 chief cities. FTC spans Davega for not giving enuf ad prominence to requirement that customer must buy antenna kit with certain bargain sets. Clarostat introduces line of 8 voltage-dropping power cords, plus one for cutting 220 to 110 v.

Aerovox says 400 walked out of their plant, but CIO calls it 800. Orkil Elec. Co., of Hartford, Conn., won the G-E Home Laundry sales contest, with 314.3% of quota. Air King Products of Bkln. has agreed to FTC order & won't classify balance or ballast tubes as "tubes" in its "14-tube" jobs. Hey, you speaker mfrs! They're selling remote speakers (end table models & such) in Britain; it can happen here.

NYC's WQXR announces plans to best shows recorded on 7 mm. tape with sapphire stylus. Philco received license to telecast on 204-210 mc., 15 w.; sta. may be in Philly or near Chi. NBC's O. B. Hanson's call for his boat xmtr is WNRE—"World's Nicest Radio Engineer"? Burgess Bats are out with a new lantern display, to help push this dealer sideline. 1939 Parts Trade Show will be held in Chi. despite coastal fairs. Sparks-Withington have taken out a license to mfr. facsimile under Finch patents.

OFF THE PRESS

(Continued from page 292)

THE RADIO SERVICEMAN, V. 1, No. 6. 4 pp. The Radio Servicemen of America, Inc., 304 S. Dearborn St., Chicago, Ill. This issue introduces official emblem of ass'n, commences listing bylaws, gives news of chapters.

1939 FALL & WINTER "MASTER" CAT. No. 73. 188 pp. Wholesale Radio Service Co., 100 6th Ave., N.Y.C. Lists Lafayette receiver line, sound systems, p-a. phono recorders, playbacks, s-w receivers and xmtrs, television kits, test equip't, accessories, parts & cameras. Sent on request from nearest branch.

CONDENSED CAT. No. 10. 8 pp. Hickok Electrical Instrument Co., 10514 Dupont Ave., Cleveland, O. Prices & specifications of test equip't, signal generators, etc. Features new "Show Lab" panel, to integrate instruments.

1939 CAT. 180 pp. Allied Radio Corp., 833 W. Jackson Blvd., Chicago, Ill. Lists new Knight line, service instruments, amateur-experimenter equip't, p-a systems, inter-communicators, recorders, playbacks & parts. Sent on request.

SRC HAM NEWS. 20 pp. Spokane Radio Co., 611 1st Ave., Spokane, Wash. Parts, circuits & information of interest to ham & experimenter are included, with some ads.

MIDLAND NEWS — CONTEST EDITION. 8 pp. Midland Television, Inc., Power & Light Bldg., Kansas City, Mo. Announces \$1,000 contest; prizes in cash & scholarships. Names winners of a previous contest. Gives school & other news.

SYLVANIA NEWS, V. 7, No. 10. 4 pp. plus 4 pp. insert. Hygrade Sylvania Corp., Emporium, Pa. Announces mdse. prizes for photos of shops, gives news & data for Servicemen. Insert gives technical & other data; introduces C-R tube 906.

\$'s & #'s

(Continued from page 292)

(largest group), 31.8%. V-p S. M. Randall is optimistic, as 56.9% are over 3 yrs. old —& farmers have money. 58% of those surveyed being mortgage-free; debt-to-value ratio only 18%.

BLOATED BONDHOLDERS? —G-E employees, ex-emps. & heirs of late emps. to the no. of 26,297 owned or had subscribed to \$28,964,390 Employee 5% Bonds—almost 4 million more than previous yr. Increase was 19.6% in no., & 15% in value. Total value of bonds of this class owned or being paid for exceeded 4 1/2 million on June 30. As of same date, Additional Pension Fund (over 51,000 participants) held \$11,665,000 of same.

RECORD RECORD:—According to J. M. Marks, gen. mgr. of Fada, who made a survey of phonoradio market. RCA-Victor sold 538% more records in '38 than in '33. Decca sells over 1,000,000 records annually.

PLATTER PLUGS:—World Broadcasting System reports sponsored business up 24% for the first 1/2 of '38. Amount: 17,985 sta. hrs.

DISCS DEVELOPING:—Victor Record Society, a "package deal" is pulling 'em in at the rate of 2,000 per wk.—and it's only 21 wks. old! 80% of members are new record buyers; 60% hope to get bigger & better phonos in future. It's a combo offer—discs & player.

TRIPPERS TOUR:—Showing the interest of the world in things technical, 56,411 people, most of whom were merely on trips to Schenectady, toured the G-E plant in first 6 mos. of '38. Receptionist Field expected no. to double in Jul. & Aug., vacation mos.

1,050,000 SETS:—Total sets in S. America are estimated at a little over 1,050,000, with almost 60% in Argentine.

FARMERS BUYING:—Even through the various depressions, farmers bought radios. Test census of 3,000 farms in 40 states shows growing ownership. Saturations were 6% on 5/1/'25, 29% on 5/1/'30, 62% on 1/1/'38. Favorite shows were farm news & lighter musicals. Govt. survey shows also that while only 44.2% own pianos, 70 to 93.7% own radios, depending on section queried.



E. H. RIETZKE PRES. OF CREI

It's YOUR Job Today

... to prepare for a better radio job tomorrow!

CREI training insures your future

• Don't say you never had the opportunity to get ahead—for here it is! Radio wants you—and needs you—for those important jobs that new equipment and methods have created. But, you must have training first. CREI courses in Practical Radio Engineering will give you the ability to qualify for a better job. Today's your chance to send for our important story.

Just Off the Press!

Write for **FREE** New illustrated booklet

"A Tested Plan for A Future in Radio"



CAPITOL RADIO ENGINEERING INSTITUTE
Dept. RC-11, 3224-16th St. N.W., Wash., D. C.

See Your Jobber

about the new Brush Mikes \$23.50 list—Super Level—minus 46 db.

Watch for further announcements

The Brush Development Company
3312 Perkins Avenue, Cleveland, Ohio

6-VOLT UNIVERSAL POWER PACK

LISTS \$15.00

At Less Than Price 6-Prong Synchronous Vibrator Alone!

Operates 2 volt set from 6 volt storage battery, also operates 6 Volt house sets, auto sets, S.W. transmitters and receivers. Output, 180 Volts at 50 M.A. On 1 Volt cell supplies 120 Volts at 30 M.A. Housed in case 3"x4 1/4"x6 3/4". Slight. Only \$32.95 NET

25% Deposit Required with Order. Balance C.O.D.

ARROW SALES CO. 27 S. JEFFERSON ST. CHICAGO, ILL.

COMPLETE DYNAMIC TESTING

Direct, quick, practical instruction for complete 14-point check of all receivers with cathode rays easily mastered by anyone who can read a circuit diagram. Without it, you're behind the times! Get your copy TODAY!

50c

FREE WITH ANY C-B INSTRUMENT

Clough-Brengle Co., Chicago, Ill., U. S. A.

WHEN YOU THINK OF AMPLIFIERS

REMEMBER TO SEND FOR OUR **FREE 1938 P. A. CATALOG** of Amplifiers Designed by A. C. Shoney

AMPLIFIER CO. OF AMERICA
17-47 West 20th St., New York, N. Y.

15 NEW TUBES!

(Continued from page 283B)

Amplification factor	25
Transconductance	1,000 micromhos
Plate No. 2 (Sharp Cutoff)	
Plate voltage	250 250 volts
Grid bias	-9.5 -1.5 volts
Plate current	0.01- 4.5 ma.
Amplification factor	33
Transconductance	950 micromhos

6AF6G—TABLE XII

Ratings

Heater voltage (A.C. or D.C.)	6.3 volts
Heater current	0.15-amp.
Max. target voltage	135 volts
Min. target voltage	90 volts
Max. control electrode supply voltage	135 volts

Tuning Indicator

Target voltage	100 135 volts
Control electrode voltage (approx.)	60 81 volts
(For shadow angle = 0°)	
Control electrode voltage (approx.)	0 0 volts
(For shadow angle = 100°)	
Target current*	0.9- 1.5 ma.
(With control electrode voltage = 0)	

*Subject to wide variation.

832—TABLE XIII

Tentative Characteristics and Ratings Unless otherwise specified, values are for both units

Heater (A.C. or D.C.):	6.3 volts
Voltage per unit	6.3 volts
Current per unit	0.8-ampere
Transconductance, for plate cur. of 30 ma.	3,000 approx. micromhos
Grid-screen mu-factor	7
Direct interelectrode capacities (each unit):	Grid-plate (with external shielding), 0.05-max. mmf.; Input, 7.5 max. mmf.; Output, 3.8 max. mmf.
Screen-cathode capacity (including internal screen bypass condenser)	65 approx. mmf.

Maximum Ratings and Typical Operating Conditions

As Grid-Modulated Push-Pull R.F. Power Amplifier—Class C Telephony

Carrier conditions per tube for use with a max. modulation factor of 1.0

D.C. plate voltage	400 max. volts
D.C. screen-grid voltage (grid No. 2)	250 max. volts
D.C. grid voltage (grid No. 1)	-100 max. volts
D.C. plate current	55 max. ma.
Plate input	22 max. watts
Screen-grid input	3.4 max. watts

1619—TABLE XIV

Tentative Characteristics and Ratings

Filament voltage (A.C. or D.C.)	2.5 volts
Filament current	2 amperes
Transconductance, for plate cur. of 50 ma.	4500 approx. micromhos
Direct interelectrode capacities: Grid-to-plate, 0.35-mmf.; Input, 10.5 mmf.; Output, 12.5 mmf.	

Maximum Ratings and Typical Operating Conditions

As Single-Tube Class A₁ Amplifier

D.C. plate voltage	400 max. volts
D.C. screen-grid voltage (grid No. 2)	300 max. volts
Screen input	3.5 max. watts
Plate dissipation	15 max. watts

Typical operation with fixed bias:

D.C. plate voltage	300 volts
D.C. screen voltage	250 volts
D.C. grid voltage (grid No. 1)	-10 volts
Peak A.F. grid voltage	10 volts
Beam-forming plate voltage	0 volts
Zero-signal D.C. plate current	44 ma.
Max.-signal D.C. plate current	46 ma.
Zero-signal D.C. screen current	4 ma.
Max.-signal D.C. screen current	6 ma.
Load resistance	8,800 ohms
Total harmonic distortion	7 per cent
Max.-signal power output (approx.)	3 watts

HY615—TABLE XV

Tentative Characteristics

Heater	
Voltage	6.3 volts
Current	.15 amp.
Approx. interelectrode capacities: C-g-p = 1.8 mmf.; C-g-k = 1.4 mmf.; C-p-k = 0.6-mmf.	
Amplification factor	20
Mutual conductance	2,200
Plate resistance	10,000

R.F. Power Amplifier & Oscillator, Class C*

D.C. plate voltage	250 volts max.
D.C. grid current	4 ma. max.
R.F. power output*	2.5 approx. watts
D.C. plate current	20 ma. max.

*At 300 megacycles.

STOP! LOOK!



And Read the News About RCA'S SENSATIONAL NEW TUBE TESTER!



COSTS ONLY \$37.95

AGAIN, RCA comes through with a winner! This time, it's the sensational new tube tester—that not only offers you more stand-out features than any other—but which costs only \$37.95 net.

Look at its features! They'll convince you that once more, RCA combines the finest quality with the greatest value!

- Only RCA Radio Tube Tester Offers All These Features*
- 1 Test new 1-1/2 volt battery tubes.
 - 2 Tests every standard type of receiving tube including all ballast tubes. Also tests cathode ray tubes for shorts and emission. All tests made according to RMA standards.
 - 3 Tests four prong and octal base ballast tubes for noisy welds and opens.
 - 4 Tests Magic Eye tubes for brilliance and opening and closing of eye.
 - 5 Tests voltage drop on all types of Gas Tubes, such as OA4-G, OZ4-G, 874, and others.
 - 6 Easily operated. All operating instructions and settings shown on simplified coller chart.
 - 7 One Finger Operation. Buttons released or retained automatically as required for testing.
 - 8 Shows line voltage up to instant of actual test. Not necessary to set line voltage before inserting tube in socket.

Easily Portable... Ideal for Service Work!

The large illustration at the top shows the RCA Radio Tube Tester as designed for counter use. Stock No. 156-A, net price \$37.95. The unit is also available with cover and snap-type handle for portable use. Stock No. 156, net price \$39.95.

RCA 3" Cathode Ray Oscillograph



This is RCA's newest and finest general purpose 3 in. Oscillograph. Has many new features all at an attractive price. Provides an easily read image without requiring expensive accessory equipment of larger tubes. All controls located on front panel. Sensitivity—20 volts (RMS) per inch deflection without amplifier—with amplifier, 0.5 (RMS) per inch deflection.

Stock No. 155—\$63.95 net

Over 325 million RCA radio tubes have been purchased by radio users... in tubes, as in parts and test equipment, it pays to go RCA All the Way.

RCA presents the Magic Key every Sunday, 2 to 3 P. M., E. S. T., on the NBC Blue Network



RCA Test Equipment

RCA Manufacturing Co., Inc., Camden, N. J.
A Service of Radio Corporation of America

Please Say That You Saw It in RADIO-CRAFT

The Serviceman's Speaker



Model 8LU

A Completely Universal Speaker for Radio Service Work

- Universal Transformer
- Universal Field
- Attractively Priced
- Stocked in the following sizes: 5"—6" and 8"

Wright-DeCoster quality throughout.
Write for descriptive matter and prices

Wright-DeCoster distributors are always anxious to cooperate.

WRIGHT-DECOSTER, Inc.

2251 University Ave., St. Paul, Minnesota
Export Dept.: M. Simons & Sons Co., New York
25 Warren St., New York
Cable Address: "Simontrice"
Canadian Representatives:
Wm. F. Kelly Co., 1207 Bay St., Toronto, Ontario
Taylor & Pearson, Ltd., Edmonton, Alberta

RADIO VOCATION TODAY

(Editorial—continued from page 260)

tunities today than ever before.

Might I suggest to all those who wish to break into radio that they pursue a carefully laid out plan of action. This plan first necessitates honest stock-taking of one's self. Start writing your good points on one side of the ledger, then list your poor points on the other side. Try to be honest with yourself and do not over-stress either the good or the poor points. Then submit your inventory to a close relative or intimate friend for double-checking.

When stock-taking is completed consult the branches and sub-branches of the radio industry listed on page 260. It should give you an insight into what branch you would best fit.

As in every other endeavor, unless you are a born genius, you must always come back to education, whether gained through book knowledge, school or college. While it is unquestionably true that hundreds of men have gained entrance into the radio industry by the study of books, thousands of others have not been so fortunate in this respect. High schools and colleges, on the other hand, only give you a general training; as a rule they do not go into specialization. But there remain the residential radio and technical schools as well as the radio correspondence schools, all of which are geared to give you a foundation, upon which your radio career is to be reared in years to come.

As I have maintained for many years the best answer to your problems is contained in the one word—SPECIALIZATION. No matter what branch of radio you try to enter, always remember that what the industry needs most and needs constantly is *Specialists*. So whatever branch you try to

fit into, you must study every angle of it from every possible vantage point, so that you will become letter-perfect in all that this particular radio branch stands for. If you do this, your battle will be half-won and your entrance into the radio industry will not present many serious problems for you.

THE RADIO INDUSTRY

(Continued from editorial page)

- (9) POLICE RADIO
- (10) FIRE PATROL RADIO
- (11) AMATEUR RADIO
 - a—Short-Wave and Ultra-Shortwave Research
- (12) AVIATION RADIO
 - a—Automatic Radio Landing Systems
 - b—Radio Compass
 - c—Radio Direction Finding
 - d—Radio Robot Pilot Systems
 - e—Radio Beacons
 - f—Plane-to-Ground Communications
- (13) MARINE RADIO
 - a—Ship's Operator
 - b—Marine Radio Direction Finding
 - c—Radio Compass
 - d—Ship-to-Shore Radio Telephony
 - e—Ship's Public Address System
 - f—Automatic SOS Alarm System
- (14) RECORDING
- (15) PUBLIC ADDRESS
 - a—Inter-Office Communication
 - b—Hearing-Aids
 - c—Sound Movies
 - d—P.A. Systems on Ships
 - e—P.A. Systems in Schools, Night Clubs, Auditoriums, etc.
 - f—P.A. Rental Business
- (16) RAILROAD RADIO
 - a—Train Dispatching by Radio
 - b—Radio Reception (for entertainment on trains)
 - c—Radio "Barkers" on Trains
 - d—Radio Communication with Trains
- (17) ELECTRONICS
 - a—Photoelectric Devices — There are over 200 applications of photoelectric cells in commercial devices of all types.
 - b—Electronic Music
 - c—Telescope Controls
 - d—Photographic Aids
 - e—"Lie" Detectors
 - f—Research
 - g—Metal and Metal-Ore Locators
 - h—Insect Exterminators
- (18) RADIO TELEMCHANICS
 - a—Remote Control of Ships
 - b—Remote Control of Airplanes
 - c—Remote Control of Motor Vehicles
- (19) RADIO IN MEDICINE
 - a—Short-Wave Diathermy
 - b—Radio Surgery
 - c—Radio Stethoscope
 - d—Radio Diagnosis
- (20) RADIO SCHOOLS
 - a—Engineering
 - b—Servicing
 - c—Communications
 - d—Broadcasting Talent
- (21) TALKIES (Home, Industrial, School, Theatres)
 - a—Design
 - b—Installation
 - c—Servicing

SEND TODAY FOR THIS CATALOG

FREE! 1939 Catalog of Public Address, Radio Service, and Amateur Equipment

Brings you up-to-date on the new things for 1939. Many "just-out" items you'll want to know about. Nationally Advertised Lines sold on our Liberal Easy Payment Terms and backed by our famous guarantee to satisfy you completely. Your copy of this catalog is ready for mailing—Where shall we send it? Ask for Catalog No. 8132. Address: Personal Service Dept. SEARS, ROEBUCK and CO., Chicago, Ill.

SEARS ROEBUCK AND CO.

UNIDIRECTIONAL DYNAMIC



D9T
 ← BACK—No Pickup
 ← FRONT—Full Coverage
 VOLUME INCREASED by Reducing Feedback
 D9T, List \$37.50, High Imp. 25' Cable
 D9, List \$35.00, Low Imp. 25' Cable

Write for Catalogue No. 29
 Manufacturers Full Line Dynamic, Crystal, and Carbon Microphones and Stands

AMERICAN MICROPHONE COMPANY, INC.
 1915 SO. WESTERN AVE., LOS ANGELES, CALIF.



D5T
 Dynamic
 List
 \$32.50



D7T
 Dynamic
 List
 \$22.50

Please Say That You Saw It in RADIO-CRAFT

Attractive
MODERN DESK LAMP
Absolutely **FREE**
READ THE DETAILS

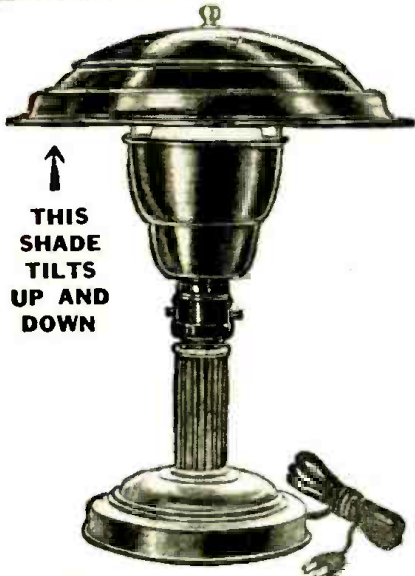

JUST THINK OF IT—you can get absolutely **FREE**, the beautiful desk lamp shown at the left. This attractive desk lamp is suitable for home, desk, den, office, laboratory, studio or workshop. It is sent to you by the publishers with their compliments for a one-year subscription to **RADIO-CRAFT**. Look at the many fine features which this handsome desk lamp has. Read the list below.

HERE ARE THE LAMP FEATURES!

- ⊛ Constructed of metal with attractive bronze finish.
- ⊛ Scientifically constructed to give glareless, diffused light.
- ⊛ Helmet-type shade can be tilted to any convenient angle.
- ⊛ Stands 13" high and has 10" metal shade.
- ⊛ 5-foot rubber insulated cord and plug.
- ⊛ Constructed to last for many years.

Clip Coupon Today—and Mail!

Send your subscription today to **RADIO-CRAFT** for One Year (12 issues) and receive absolutely **FREE** one of these truly remarkable desk lamps. New subscribers are accepted or you may extend your present subscription another twelve months under this offer. Mail your remittance of \$2.50 (Plus 25c for shipping charges on lamp) to the publishers of **RADIO-CRAFT**. (Canada and foreign \$3.25) You will promptly receive your **FREE DESK LAMP** by return mail. Use the coupon below to order your subscription.

RADIO-CRAFT

99 Hudson Street NEW YORK, N. Y.

RADIO-CRAFT
99 HUDSON STREET, NEW YORK, N. Y.

Gentlemen: Enclosed you will find my remittance of \$2.50 for which enter my subscription to **RADIO-CRAFT** for One Year (12 issues). Send me promptly my **FREE DESK LAMP**. (Canada and foreign \$3.25) In U. S. add 25c additional to cover shipping charges on lamp.

() NEW SUBSCRIBER
() EXTEND PRESENT SUBSCRIPTION

Name

Address

City State

(Send remittance by check, money order or unused U. S. Postage stamps. Register letter if you send cash or stamps.)

RC-1138

NEW 42-PASSENGER AIRLINER BOASTS SUPER-RADIO SYSTEM

(Continued from page 271)

weather, and marker signals while holding 2-way communication with the landing field. All power is supplied from the ship's 800-cycle auxiliary lighting plant. An intercommunicating system, that may be plugged into regular Bell System lines when the ship is on the ground, connects the pilot, co-pilot, flight engineer, and stewardess. During flight the pilot may talk over any one of 10 different frequency bands, and a special direction-finding loop enables him instantly to check the ship's position with respect to ground stations.

All major components of the system are assembled to form a panel installed on the "bridge" immediately behind the co-pilot's position. This unit, operated remotely from a master control column which rises between the pilot and co-pilot, is entirely self-contained and is comprised of the transmitter; communication, beacon, auxiliary, and marker receivers; and the intercommunicating system amplifier. Individual control panels, mounted at both flying positions, switch either headset independently to any or all receivers without affecting what is heard in the other headset. Facilities are also included in the individual panels for switching the microphones either to the ship's transmitter or to the intercommunicating system; for signaling the various stations connecting with the system; for adjusting headset volume; and for placing the transmitter on the air.

As the ship passes from one radio zone into the next, the transmitter and communications receiver to which it is geared are shifted progressively through 5 pairs of "day" and "night" frequencies, by means of a rotary dial on the transmitter panel. Instantaneous shift from day to night frequency is effected by a push-pull lever located on the master control column. Quartz-plate oscillators of new and superior design hold the several frequencies within required limits and a forced draft ventilation system cools the active elements of the transmitter with filtered air.

The communications receiver, too, is crystal-controlled and is of the superheterodyne type. Its maximum sensitivity is adjusted from the master control column and thereafter is regulated automatically by a special vacuum tube circuit.

The beacon receiver is basically similar to the communications receiver but differs in its purpose and in several minor features of mechanical design. Provision is made for reception on either a conventional single wire antenna, which is located beneath the fuselage, or from the shielded direction-finding loop enclosed within the ship's wooden nose. The receiver is continuously tunable between the frequency limits of 195 and 415 kilocycles by means of an illuminated dial on the control column which also contains the sensitivity control knob and an indexed dial showing the loop position.

An auxiliary receiver, which may be operated from battery supply in event of power failure, covers all of the frequencies to which the pilot would normally have occasion to listen. It is tuned remotely from the control column by flexible shafting.

Marker stations are indicated by a series of colored signal lights which appear in the cockpit and which may be augmented by an audio signal heard in the headset. The crystal-controlled receiver, which is of the superheterodyne type, requires no operating attention during flight.

(Continued on page 318-320)



you can't beat R.C.P.

MODEL 307C DYNOPTIMUM TUBE TESTER

Checks all latest tubes as well as old types. Tests for shorts and leakage between all individual elements while hot. Will also test hot cathode leakage. Uses three inch Dynatron meter with "good-bad" multi-colored scale. Accurate line voltage indicator on meter. Complete with rectifier, tube and tube charts, ready to use . . . your cost **\$16.95**
Also available in portable model (No. 307P) Only **\$18.95**



MODEL 432 TROUBLE SHOOTER

Lowest priced "legitimate" tester on the market today. Yet quality has not been sacrificed to achieve its amazing economy. Compact pocket size weighing just 2 1/2 oz.; its multiscale Dynatron meter accurate within 2%. Has individual low ohm scale. D.C. volts—0.5/0.50/0.500/0.1,000. D.C. ma. 0.1/0.10. Ohms 0.500/0.50,000/0.500,000. Complete nothing else to buy **\$5.95**



Other testers in the complete line of high quality—low priced R.C.P. instruments described in new catalog. Use convenient coupon for your copy.

See the R.C.P. line of quality instruments at your local jobber—or if not available in your locality use coupon below for your order and specify your jobber.

RADIO CITY Products Co., Inc.
88 PARK PLACE NEW YORK CITY

RADIO CITY PRODUCTS CO., INC.
88 Park Place, New York RC-118

Rush to me new catalog.....
Attached please find M.O. Check
for model tube tester.

NAME

ADDRESS

CITY STATE

SPECIAL—NEW TUBE NUMBER
Tell your newsdealer NOW to reserve
December, 1938, **RADIO-CRAFT** for you.

FACTORY-TO-YOU SAVES YOU UP TO 50%

WORLD'S GREATEST RADIO VALUE!
15-TUBE WORLD-WIDE MIDWEST

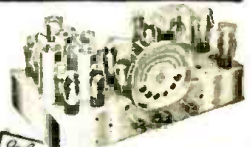

It is easy to modernize old radio by buying this new \$29.95 fifteen-tube world-wide chassis in your present cabinet. Get exciting world-wide reception. New features! (Only \$76.75 for Super Deluxe 17-Tube, 3-Band Console shown here.) Easy payments. Enjoy 30 days' FREE trial. Money-back guarantee. Send penny post card or write for new FREE 1939 catalog and trade-in plan. Dept. 12-EE, Midwest Radio Corporation, Cincinnati, Ohio.



Please Say That You Saw It in **RADIO-CRAFT**

NUMBER ONE You don't have to sell CINAUDAGRAPH QUALITY. Your customers know all about that. Here is one "hidden part" that has built a name for itself through consistently brilliant performance. And today, you can buy Cinaudagraph speakers for both indoor and outdoor applications at competitive prices!

Extensively used by the majority of set and P.A. equipment manufacturers, Cinaudagraph speakers will be found wherever quality performance and dependability are required.



SPEAKER line

Cinaudagraph speakers are available in electro-dynamics from 5" to 27" and permanent magnets from 5" to 18". Send for new catalog to Dept. 8L

CINAUDAGRAPH CORPORATION
SPEAKER DIVISION EXPORT DEPARTMENT
STAMFORD, CONNECTICUT 100 VARICK ST., NEW YORK

MONEY-SAVING CAPACITORS



AEROVOX HYVOL
TRANSMITTING CAPACITORS
TYPE 2009

● Mass-produced for new low prices. HY-VOL capacitors for transmitting and other high-voltage applications are now available in oil-filled (heavy-duty) and wax-filled (normal-duty) types. ● Welded steel can. High-tension pillar terminals. Conservative ratings. 600 to 3000 v. D.C.W. ● Compare prices. Compare quality—at your local jobber's.

AEROVOX CORPORATION
70 Washington St. : : Brooklyn, N. Y.
IN CANADA: AEROVOX CANADA, Limited Hamilton, Ont.

"SIGNAL-TEST" SYSTEM OF TROUBLE-SHOOTING

(Continued from page 293)

kc. to 4,900 kc., and from 4,800 kc. to 15,000 kc. Pick-up to the circuit is through a shielded cable which terminates in a capacity of less than 1 micromicrofarad. The input circuit is equipped with a gain control.

In order to provide for maximum sensitivity when working with modern super-heterodyne receivers with comparatively low oscillator output voltage, high gain is obtained in the oscillator channel by using a type 1852 tube as the amplifier.

The oscillator channel is used when checking oscillator operation over the 600 kc. to 15,000 kc. range. When checking for operation of oscillator systems without regard to frequency of the output, the electronic voltmeter channel is used.

A.F. CHANNEL

V8A to V9—The A.F. channel employs 3 tubes: an amplifier, a diode rectifier and an electron-ray indicator.

It is resistance-capacity coupled and "flat" over a frequency range of 50 to 50,000 cycles. The sensitivity of the amplifier is 0.1-volt for full indication and is operative over an input voltage range from 0.1-volt to 1,000 volts. A jack is provided in the output circuit of the amplifier so that the signal output can be fed to headphones or to an oscilloscope for aural or visual observation. The continuously variable attenuator and a switch-controlled, single-step attenuator provide attenuation over a ratio of about 10,000 to 1.

ELECTRONIC VOLTMETER

V10—This voltmeter employs a tube and a meter-type indicator.

The meter has a center zero and indicates both positive and negative voltages with respect to ground. The range of voltages covered by the meter is as follows: -5 to 0 to +5; -25 to 0 to +25; -100 to 0 to +100; and -500 to 0 to +500. The input resistance of the instrument on all scales is 10,000,000 ohms, which means that on the low-voltage scale, the resistance is equal to 2,000,000 ohms/volt. All D.C. operating and control voltages may be measured with the instrument, thus making it possible to measure R.F., I.F., A.F., and oscillator voltages directly at the grid and plate without interfering with the operation of the receiver.

WATTS INDICATOR

V4B & V7—The watts indicator employs 2 tubes: a diode rectifier and an electron-ray indicator.

It is calibrated to indicate the power consumption of the receiver under test and covers a range from 25 to 250 watts. This unit is automatically connected into the circuit when the receiver is plugged into the receptacle provided for that purpose. To obtain the amount of power consumed, the watts-level pointer is turned until the shadow in the watts indicator is a minimum. The eye is just closed. The power in watts then is read directly from the scale engraved on the panel.

POWER SUPPLY

V12—The power supply employs a full-wave rectifier and functions as the source of the operating voltages for all the tubes in the Chanalyst.

Exceptional care has been taken in the design of the filter so that the hum level is extremely low.

THE CABLES AND PROBES

Four probe leads are furnished. The (Continued on page 317)

Index to advertisers

A	
Aerovox Corporation.....	314
Allied Radio Corporation.....	303
American Microphone Co.....	312
The American Red Cross.....	317
American Television Institute.....	308
Amperite Corporation.....	296
Amplifier Co. of America.....	311
Arrow Sales Company.....	310
B	
Browning Laboratories, Inc.....	318
The Brush Development Co.....	304
C	
Capitol Radio Engineering Inst.....	311
Central Radio Laboratories.....	306
Cinaudagraph Corporation.....	314
Classified Section.....	316
Clough-Brengle Company.....	311
Cornell-Dubilier Corp.....	318
Coyne Electrical School.....	259
E	
Eastern Radio & Tel. Labs.....	302
Electronic Products Company.....	302
H	
Hammarlund Mfg. Company.....	296
Hickok Elect. Instrument Co.....	308
Hudson Specialties Company.....	316
Hygrade Sylvania Corporation.....	298
I	
International Correspondence Schools.....	306
International Resistance Company.....	300
L	
Lancaster, Allwine & Rommel.....	317
Lincoln Engineering School.....	309
M	
Meissner Mfg. Company.....	Back Cover
Midwest Radio Corporation.....	313
Model's.....	309
N	
National Plans Institute.....	309
National Radio Institute.....	257
National Schools.....	304
National Union Radio Corp.....	302
New York Radio Supply Co.....	307
New York YMCA Schools.....	317
R	
Radio & Technical Publ. Co.....	296, 305
Radio Circular Company.....	306
Radio City Products Company.....	313
Radio Training Association.....	303
Radolek Company.....	317
RCA Institutes, Inc.....	302
RCA Manufacturing Co., Inc.....	311
Readrite Meter Works.....	295
Remington Rand, Inc.....	307
John F. Rider.....	307
S	
Scientific Diathermy Corp.....	305
Sears, Roebuck Co.....	312
Service Instruments, Inc.....	301
Simpson Electric Company.....	310
Solar Mfg. Company.....	305
Sprague Products Company.....	310
Sprayberry Academy of Radio.....	Inside Back Cover
Superior Instruments Co.....	307, 297
Supreme Instruments Corp.....	Inside Front Cover
T	
Teletran Products Company.....	318
Test Equipment Co. of America.....	315
William A. Thomas Company.....	317
Triplett Elec. Instrument Co.....	259B
Try-Mo Radio Co., Inc.....	306
U	
United Radio Company.....	307
W	
Wellworth Trading Company.....	306, 309
Wholesale Radio Service Co., Inc.....	261, 293, 304
Wright-DeCoster, Inc.....	312

(While every precaution is taken to insure accuracy, we cannot guarantee against the possibility of an occasional change or omission in the preparation of this index.)

Please Say That You Saw It in RADIO-CRAFT

TECO TEST EQUIPMENT Sold with a GUARANTEE & 10 DAYS FREE TRIAL!!!

Buy direct from the factory. Save 50%. If the Instrument you buy does not meet your needs, return it for full credit on any other TECO equipment. Buy TECO and SAVE the difference!



NEW TECO TUBE TESTER

Model T-10 A genuine achievement! For accurate and rapid work. Has d'Arsonval moving coil meter. Tests all types of tubes. For use on 110 V., 60 cycle AC.

Features • Tests all 4, 5, 6, 7a, 7L and octal base tubes. • Tests by the well established emission method for tube quality, directly read on the Good ? Bad scale of the meter. • Affords separate neon test for leakage and shorts between elements. • All services performed with 5 controls at maximum—many tests not requiring all controls. • Modern attractive etched panel housed in rugged leatherette carrying case with removable hinged cover and handle. • 60 cycle AC operation. • Supplied with instructions and reference table covering all tubes which you will commonly encounter in servicing. Size 11 3/4 x 9 1/2 x 3 3/4". Net Price.....

\$11⁷⁵

TECO POCK-O-METER AC and DC

A new pocket size volt-ohm-milliammeter that includes AC measurements and is the lowest priced, full-service instrument ever offered! Has 3" d'Arsonval movement 0-1 milliammeter. Comes with etched panel.

SPECIFICATIONS

5 DC ranges: 0/1.5/15/25/75/500 volts.
5 AC ranges: 0/15/40/75/200/1200 volts.
4 DC current ranges: 0/1/10/100/500 ma.
2 resistance ranges: 0/500/500,000 ohms (low ohms read to 1 ohm)
Pock-O-Meter supplied complete with batteries, test leads, and instructions. Size 6 1/2 x 3 1/2 x 2 1/2"; shipping weight 5 lbs. Our net price.....

\$8⁴⁵

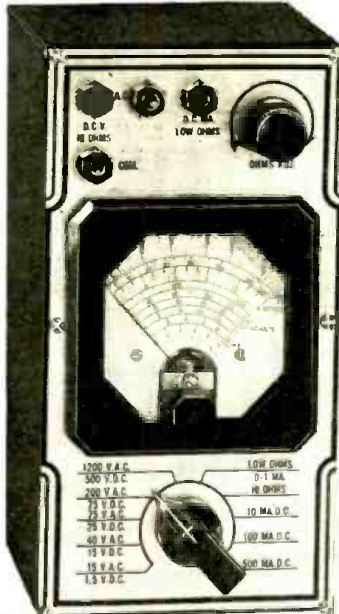

NEW TECO MULTIMETER

MODEL T-15 Here's the unit you need for rapid, accurate measurements. A 1000 ohms per volt type instrument featuring d'Arsonval type movement 0-1 milliammeter. Accuracy 2%. Attractive etched metal panel. For use on 110 V., 60 cycle AC. RESISTANCE RANGES: 0-500 ohms, 500-5 megohms. HIGH AND LOW CAPACITY SCALES: .0005-1 mf. and .05-200 mf. COMPLETE AC and DC VOLTAGE and CURRENT RANGES. DC Voltage: 0-15, 0-150, 0-750 volts; AC Voltage: 0-15, 0-150, 0-750 volts; DC Current: 0-1, 0-15, 0-150, 0-750 ma.; AC Current: 0-15, 0-150, 0-750 ma. THREE DECIBEL RANGES. TECO Multimeter comes complete in carrying case with test leads and instructions. Size 11 3/4 x 9 1/2 x 5 1/2". Shipping weight 8 lbs. Our net price.....

\$13⁶⁰

THE NEW MODEL T-25 SIGNAL-GENERATOR PLUS BUILT-IN OUTPUT METER



Specifications

Works on 90-130 volts AC.
Generates radio and intermediate frequencies, 100 kc. to 60 mc. in six bands, selected by front-panel switch operation. Two audio services, 30 cycle sine-wave, and five saw-tooth switch-selected frequencies, 100, 100, 1000, 5000, and 7500 cycles. The audio is servicable as modulation on all R.F. and I.F. bands, also may be taken out independently.
Features a Crone 10" full vision oblong dial. Crystalline black finish shield cabinet.
Three tubes used: one 6J5C oscillator, one 25Z6 rectifier, and one modulator tube.
The TECO T-25 Signal Generator complete with tubes and test leads. Size: 9" x 11" x 5 1/2". Shipping weight, 18 pounds. Net Price.....

\$17⁴⁵

TECO T-20 COMBINATION SET TESTER



Complete Set Analysis at Your Finger Tips

Combines the functions of the Teco T-10 Tube Tester and T-15 Multimeter. A complete testing laboratory for shop use. A portable trouble shooting laboratory which you can take with you on the job. Fast, accurate trouble shooting with a single service instrument. An invaluable asset to modern field servicing. Specifications of the T-20 are the same as those given for the T-10 Tube Tester and T-15 Multimeter.

The TECO T-20 SET TESTER comes complete with an unusually large 4 1/2" d'Arsonval type meter and attractive etched panel test prods, black leatherette carrying case and instructions for use on 110 volts, 60 cycles, AC. Size 15" x 10 1/2" x 6". Shipping Weight 17 lbs. Our net price.....

\$21⁴⁵



TEST EQUIPMENT COMPANY of America

139 CEDAR STREET

RC-11

NEW YORK, N. Y.

Please Say That You Saw It in RADIO-CRAFT

STOP, LOOK & BUY!

Rockbottom Prices on Surplus, and Army and Navy Merchandise

When prices are low we buy! They're low now—**LOWER THAN THEY EVER WILL BE**—hence this sale. Most of the merchandise is new—never used; some of it reconditioned. 100% satisfaction on each transaction or your money refunded.

ORDER FROM THIS PAGE. Use the convenient coupon below. Be sure to include sufficient extra remittance for parcel post charges, else the order will be shipped express, charges collect. Any excess will be refunded. C.O.D. shipments require a 20% deposit. If full remittance accompanies order deduct 2% discount. Send money order—certified check—new U. S. stamps. No C.O.D. to foreign countries.

ORDER TODAY QUANTITIES LIMITED QUICK SHIPMENTS ASSURED

EDISON 1/50TH H.P. UNIVERSAL MOTOR

Made by Edison Electric Co. for Dictaphone machines. Can be used on 110 volt D.C. or A.C. lines (any frequency on A.C.). Double shaft, 5/16th in. diam. Any speed obtainable with suitable rheostats. Size 9" x 4" high x 3 1/2" wide overall. Ship. Wt. 8 1/2 lbs.

ITEM NO. 10
Your Price **\$2.25**



NEW FUEL PUMPS

Brown & Sharpe pumps. Brand new, never been used. Can be used for gasoline, oil, kerosene, and other fuels. Not good for water. Takes standard thread 1/2" input and output pipes. Has 1" drive shaft. Measures 4 x 3 1/4 x 3 1/2" diam. overall. Ship. wt. 8 1/2 lbs.

ITEM NO. 24
Your Price **\$4.45**

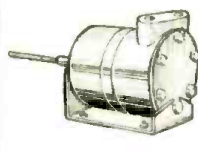

WESTERN ELECTRIC BREAST MIKE

A lightweight aircraft-type carbon microphone, with breast plate mounting. Can be adapted for home broadcasting or private communication systems. With cord and plug. Ship. Wt. 4 lbs. Illustrated as shown.

ITEM NO. 14
Your Price **\$2.45**

Macnavis Anti-Noise Microphone, also good for home broadcasting etc. With cord and plug. Ship. Wt. 2 lbs.

ITEM NO. 15
Your Price **\$1.80**



U. S. NAVY BAUSCH & LOMB TELESCOPE

Precision-built for U. S. Navy as finders on large calibre guns. **CAMERA FANS—USE IT FOR CLOSE-UPS OF DISTANT PICTURES.** Optical system comprises 7 lenses and erecting and eyepiece draw tubes. Object lens 2" variable; eye lens 1 1/2" 16" exit pupil 0.2" to 0.09". Angular field 330°; power 3 to 10; erect image; cross hairs used. Net wt. 6 lbs. Original cost said to be over \$130. Ship. wt. 10 lbs.

ITEM NO. 25
Your Price **\$14.95**



GUARANTEED REBUILT VACUUM CLEANERS

All **NATIONALLY-KNOWN** makes—**GUARANTEED FOR 6 MONTHS.** All parts, no matter how slightly worn, are replaced with **NEW** ones—we supply new bags, new corus, brushes, handles, belts and other parts. Even the chassis itself is replated and polished. We've been selling these rebuilt machines since 1930; all our customers are satisfied, or money back. **THERE'S NO GRIEF WITH THESE MACHINES!**

EUREKA NO. 9—Straight suction. Fixed brush. Pistol grip handle. Switch in handle. Polished aluminum housing, 13-inch nozzle. Ship. wt. 20 lbs. List price, \$42.50.

ITEM NO. 26
Your Price **\$12.95**

HAMILTON BEACH—Motor driven brush. Pistol grip handle. Polished aluminum housing, 12-inch nozzle. Switch in handle. Ship. wt. 20 lbs. List price, \$89.50.

ITEM NO. 27
Your Price **\$13.95**

HOOVER NO. 105—Motor driven brush. Foot control switch. Black enameled steel metal housing, 12-inch nozzle. Ship. wt. 24 lbs. List price, \$69.50.

ITEM NO. 28
Your Price **\$13.95**



PREMIER DUPLEX—Motor driven brush. Pistol grip handle. Switch in handle. Polished aluminum housing, 13-inch nozzle. Ball bearing motor. Ship. wt. 20 lbs. List price, \$39.50.

ITEM NO. 29
Your Price **\$16.95**

ELECTROLUX NO. 11—Radical design, cylinder type motor. Complete with all attachments. Foot control switch. Box 101 uses cleaning upholstery, walls, draperies, curtains, mattresses, etc. Ship. wt. 18 lbs. List price, \$69.75.

ITEM NO. 30
Your Price **\$18.95**

HOOVER NO. 700—Agitator type cleaner. Pistol grip handle. Switch in handle. All high polished aluminum finish. Ball bearing motor. Ship. wt. 25 lbs. List price, \$79.50.

ITEM NO. 31
Your Price **\$29.50**

PORTABLE TELEGRAPH AND BUZZER FIELD SETS

Made for military use by Western Electric. A wonderful buy if only for the parts it contains. Never been used. Good for code practicing, signaling, communications, etc. Contains 2-tone, high-frequency buzzer with platinum contacts, telegraph key, telephone switches, earphone, condenser, transformers, chokes, etc. A \$50 value easily. Complete in wooden case with diagrams and instructions. Ship. wt. 12 lbs.

ITEM NO. 16
Your Price **\$5.45**

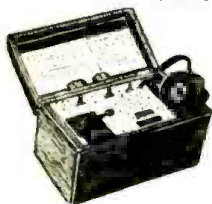

TELEGRAPHIC TAPE RECORDER

A wonderful buy! Apparatus makes a written record of code and similar messages on paper tape. An ideal machine for learning code or teaching code to groups. Radio men can easily adapt it to short-wave receivers for taking permanent records of code messages. Double pen permits simultaneous recording of two messages. Tapes are operated by battery and key while tape feeder is spring driven (hand wound). Case made of solid brass on heavy iron base. Completely reconditioned. (Glass tape readily obtained anywhere.) Original cost \$85.00. Ship. Wt. 20 lbs.

ITEM NO. 20
Your Price **\$19.95**

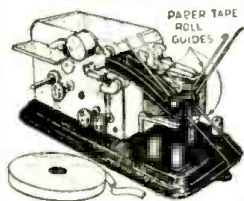

SPERRY GYROSCOPE LIQUID COMPASS

Made for U. S. Signal Corps; sensitive and accurate. Quick readings easily made from top; accurate readings of graduations through focusing magnifying lens on side of instrument. Complete with level stadia and russet leather carrying case. Excellent for boats, boy scouts, campers, hikers, etc. A few turns of wire around its case makes it usable as a galvanometer. Ship. Wt. 3 lbs.

ITEM NO. 12
Your Price **\$1.85**



ANTI-CAPACITY SWITCHES

Made by Western Electric. Double throw switch with 12 terminals—equivalent in two double-pole, double-throw switches. All contacts are of platinum plate. Original price \$3.50 each. Ship. wt. 1 lb.

ITEM NO. 23
Your Price **\$1.55**



WE HAVE NO CATALOG. ORDER FROM THIS PAGE.

HUDSON SPECIALTIES - 40-R West B'way - N.Y.C.

IT'S EASY TO ORDER—CLIP COUPON—MAIL NOW

HUDSON SPECIALTIES CO., 40-R, West Broadway, New York, N. Y. RC-1138

I have checked below the numbers of the items I'm ordering. My full remittance of \$..... (include shipping charges) is enclosed.

OR my deposit of \$..... is enclosed (20% required), ship order (C.O.D.) for balance. (New U.S. stamps, check or money order accepted.)

Circle Item No. wanted: 10 12 14 15 16 20 23 24 25 26 27 28 29 30 31

Name Address

City State

Send remittance by check, stamps or money order; register letter if you send cash or stamps.

OPPORTUNITY AD-LETS

Advertisements in this section cost five cents a word for each insertion. Name, address and initials must be included at the above rate. Cash should accompany all classified advertisements unless placed by an accredited advertising agency. No advertisement for less than ten words accepted. Ten percent discount for six issues, twenty percent for twelve issues. Objectionable or misleading advertisements not accepted. Advertisements for December issue must reach us not later than October 5th.

Radio-Craft • 99 Hudson St. • New York, N. Y.

AGENTS WANTED

MARVELOUS NEW TOY. BIG LOU SELLER. 300% profit. Write immediately. Sample free. Send quarter for packing, mailing. General Supply Co., Dept. HSR-C, Fluga, Ohio.

SALESMEN—SELL CALENDARS. COMPLETE LINE. all sizes, including jumbos; beautiful subjects. Samples free. Fleming Calendar Co., 6539 Cottage Grove, Chicago.

MEN—WOMEN SELL THE NEW BULMER CORN DE- cember. Makes corn canning easy. Bulmer Machine Works, Beltsville, Wash.

AVIATION

AIRPLANE MECHANIC'S LICENSE QUESTIONS. with answers, diagrams, \$1.25. Engine Mechanic's \$1.25. Total \$2.00 remittance. Meyer Engineering, Box 8, Hempstead, New York.

BOOKS AND MAGAZINES

WE HAVE A FEW HUNDRED RADIO ENCYCLO- pedias, by S. Gersback, second edition, originally sold at \$3.98. Book has 352 pages, weight 3 lbs., size 9 x 12 inches. Red morocco—keratin—flexible binding, serial \$2.49 in stamps, cash or money order and book will be forwarded express collect. Techifax, 558 W. Washington Blvd., Chicago, Illinois.

ASSURE YOURSELF OF GREATER PROFITS by doing radio service jobs more quickly. Authentic service guides show you the way to locate and correct troubles in any radio receiver. Gersback Official Radio Service Manuals show you how to complete more repair jobs in less time—how to earn more money by faster servicing. Turn to page 259A and learn how you can get Manuals on a free instruction plan.

HAVE YOU A SENSE OF GOLF HUMOR? COPY- righted printed booklet, "Follow Duffers." Written by a humorist. Fifteen cents. Engdahl Features Service, 36 Howard Street, New Britain, Conn.

BUSINESS OPPORTUNITIES

RELIABLE PERSON IN EACH TOWN FOR OWN advertising distribution agency. No selling. Good paying business. Dawson's Advertising, Cape Girardeau, Missouri.

TWELVE (12) MONEY MAKING PLANS. "INCLU- ding five plans" for the United Distributors, 32 Everett Street, Lyndwood, New York.

GIANT MAIL-OPPORTUNITIES. INCLUDING 52- page magazine, tips, added income ideas. All for 10c. C. Katz, 4254 N. Kimball, Chicago, Ill.

CAMERAS & SUPPLIES

AMBERTINT 16MM. CAMERA FILM \$1.85 FOR 100 feet including machine processing, Daylight loading. Weston S. Hollywood Studios, South Gate, Calif.

ARGUS EVER-READY CAMERA CASE. GENUINE top grade leather, with shoulder strap very special with this advertisement. \$1.69. Mirolex, 6241 Southwood Street, St. Louis, Missouri.

JOIN THE THOUSANDS OF CANDID CAMERA FANS a genuine milestone equipped with Wollensak 50 mm. lens, speed shutter and accurate "spy glass" view finder. Fixed focus assures sharp pictures 1 1/4 x 1 1/4 inches. Galleries with clarity up to 8 x 10 inches. Has special compartment to carry extra film roll and tripod socket for mounting. Uses economical Kodak 127 or Agfa A8 film in color or black and white—takes 16 pictures. Housing built of unbreakable bakelite composition. Camera weighs only 9 ounces; measures 5" long by 3" high by 2" wide. Easy to operate and inexpensive to use. Shipped postpaid anywhere in U.S.A. with guarantee of safe delivery \$3.98. Hudson Specialties Company, 4810 West Broadway, New York, N. Y.

COINS AND STAMPS

25 NORTH AMERICAN. ETC. FOR 10c. PRICE LISTS. Approvals. Box 194, Gloucester, Mass.

COSTA RICA TRIANGLES, ETC. FREE. SEND RE- turn postage. Clifton, Clifton, New Jersey.

FOR INVENTORS

INVENTIONS QUICKLY COMMERCIALIZED. UNPAT- ented, protection guaranteed. Pacific Inventors Agency, 2236 Post, San Francisco, Calif.

INSTRUCTION

RADIO ENGINEERING, BROADCASTING, AVIATION and police radio, sovieting, marine and Morse telegraphy taught thoroughly. All expenses low. Catalog free. Dodge's Institute, Pine St., Valparaiso, Ind.

MACHINERY

CONVERT MODEL T MAGNETIC FIELD COILS INTO arc welder. Operates from 110 volt power supply. Ideal for light welding. Instructions \$1.00. Superior Welding Company, Box 1892, Roanoke, Virginia.

MISCELLANEOUS

MEXICAN DIVORCES; NO PUBLICITY. AMERICAN attorney. Box 1736, El Paso, Texas.

PYRO PANTAGRAPH—THIS ELECTRICAL OUTFIT burns designs permanently on leather, wood, cork, zirconia, bakelite, etc. Simply plug pyro electric penell into any 110 v. A.C. or D.C. line and it is ready to use. Reduced or enlarged designs with special pantographs included. Complete kit and instructions, \$2.75. (Add postage for shipping 3 lbs.) Wellworth Trading Company, 560-R West Washington Street, Chicago, Illinois.

"A-B-C" SOLID STEEL ROD. WHAT! ALL FOR \$2.00? Yes! 5/16" rod, reel, line, 50c spoon, postpaid. Big value guaranteed. Catalogue 5c stamp. Dealers write. Factory "A", 131 Bates, Detroit, Michigan.

MONUMENTS AND TOMBSTONES

GENUINE MARBLE, GRANITE. FREIGHT PAID. Catalog free. \$11 up. United States Marble & Granite Co., A-27, Oneen, Fla.

(Continued top of next page)

(Continued from preceding page)

OFFICE SUPPLIES

ENVELOPES—1000—6 3/4" \$1.75; 1000—10"—\$2.85; 100 sheets carbon paper \$1.50; prepaid. "Everything for the office." Labalm, 603 Main, Evanston, Illinois.
CUSHION MOUNTED ONE, TWO LINES, 25c; 3 LINES, 35c. Stamp Works, Hastings, Nebraska.

PHOTOGRAPHY

ROLLS DEVELOPED—25c COIN. TWO 5 X 7 DOUBLE weight professional enlargements, 8 gloss prints. Club Photo Service, LaCrosse, Wisconsin.
ROLLS DEVELOPED—8 LARJAPRINTS (ENLARGEMENTS) 35c or 8 regular prints 25c. Star Photo, New Britain, Connecticut.

PRINTING

\$1.98 POSTPAID—250 8 1/2 x 11 LETTERHEADS AND 250 envelopes. Also, 1002 Oneida, Duluth, Minn.
SPECIAL—1000 LETTERHEADS AND 1000 ENVELOPES \$4.75 postpaid. Other printing at reasonable prices. All work guaranteed. Hustler Publishing Company, North Salem, Indiana.
1000 6X9 CIRCULARS, LETTERHEADS, ENVELOPES, postcards, \$2.95; 5000, \$9.45. All printing reasonable. Samples, Goodprint, Harrisonburg, Virginia.

RADIO

"CRYSTAL DETECTOR" HANDBOOK; 3 AMPLIFIER Plans; "Radiobuilder"—year, all for 25c. Laboratories, 7700-B East 14th, Oakland, Calif.
SELL CRYSTAL MICROPHONES, NON-DIRECTIONAL, eight-ball model, Brand new latest factory product, \$8.00. White Sound Studio, 151 West 63rd Street, New York, N. Y.

SONG POEM WRITERS

WANTED ORIGINAL POEMS, SONGS, FOR IMMEDIATE consideration. Send poems to Colonial Music Publishers, Ltd., Dept. P-69, Toronto, Canada.
SONGWRITERS! MELODY FOR WORDS \$1.00. Littig, 215 Mason Theatre, Los Angeles, California.



AT THE HELM - in time of need

RADIO COURSES

RADIO OPERATING—BROADCASTING For Gov't License Preparation

- RADIO SERVICING — a practical course
- RADIO AMATEUR CODE ● TELEVISION
- ELECTRONICS—1 yr. day course 2 yrs. eve. Day and Evening Classes. Booklet Upon Request.

New York Y.M.C.A. Schools
 4 W. 64th Street New York City
Trade and Technical School
 Licensed by the State of New York

PATENT S—TRADE MARKS

All cases submitted given personal attention by members of the firm.

Form "Evidence of Conception" with instructions for use and "Schedule of Government and Attorneys Fees"—Free

LANCASTER, ALLWINE & ROMMEL,
 PATENT LAW OFFICES

436 Bowen Bldg. Washington, D. C.

Servicing is Made Easier with

RADIO CHASSIS CRADLE!

Service shops need the RADIO CHASSIS CRADLE (chassis cradle) for efficient servicing, testing and repairing of receivers or amplifiers. Equipment clamps to cradle which can be adjusted in any angle. Accommodates chassis up to 13 x 12 x 2 1/2 inches. Excellent for displaying receivers. Write for illustrated circular RC!

WM. A. THOMAS CO., 321 Caroline St., Neenah, Wis.

"SIGNAL-TEST" SYSTEM OF TROUBLE-SHOOTING

(Continued from page 314)

cables have low capacity, are shielded, and have an outer covering of braid. The probe handles contain the coupling capacity for the R.F.-I.F. and oscillator channels. Four small copper clips, having internally-threaded sleeves, can be screwed over the prods when a permanent connection is required as in servicing intermittent receivers. Two additional flexible connectors which can be screwed over the prod so as to enable connection to the tube sockets from the top with the tubes in place are also provided.

It might be of interest in closing to say that this method of operation makes possible, in about 50 per cent of the service calls, a very thorough inspection of a receiver in the customer's home without even pulling the chassis from the cabinet, working right from the top of the chassis. As a matter of fact, it is possible to approximate the defect and thus render an approximate estimate without gambling with the time required to "pull" the chassis (take it to the shop) and render the estimate, only to be told that it is too high and, hence, lose the job.

This article has been prepared from data supplied by courtesy of Service Instruments, Inc.

Radio-Craft is very desirous of hearing from its readers, in connection with the above article. Your comments on this system of servicing will be most welcome.

SERVICING QUESTIONS & ANSWERS

(Continued from page 279)

pany. After replacing the coil and setting the trimmers, I found one station at 630 kc. which would come in on the dial twice, within about 5 kc. of each other. And another station at 1,460 kc. which will come in about 2 or 3 times on the dial, very close to each other. I have quite some radio experience and have tried the complete circuit out, but can find nothing else wrong. Could you please explain this and give me a remedy?

(A.) The trouble outlined is probably due to either of 2 causes. First, we suggest re-alignment. It is possible that the oscillator shunt condenser has been adjusted below the signal frequency. There are usually 2 settings of the oscillator shunt trimmer. The one with minimum capacity (above signal frequency) is correct.

Second, check all components in the A.V.C. circuit, as grid filter condensers in the control-grid circuit of A.V.C.-controlled tubes, for leakage. Check cathode voltages. Lack of, or insufficient bias on R.F. or I.F. tubes produce repeat points, close to one another, in tuning.

OPERATING NOTES

(Continued from page 278)

value of the resistor to 15,000 ohms the tone became as clear as a bell. Bypassing this resistor with a 0.1-mf. condenser improved the tone quality even more.

When replacement transformers are used, always use a transformer with a rating well over an average 5 tube transformer, or it will become badly overloaded.

FRANCIS COLLINS
 Collins Radio Shop

Don't miss the December Issue of Radio-Craft!

RADOLEK

EVERYTHING IN RADIO



EVERYTHING IN RADIO

Everything in radio in this Big New 1939 RADOLEK PROFESSIONAL PROFIT GUIDE.

IT GUIDE. Radolek has everything under one roof. When you order, you get just what you want, promptly and economically. Over 25,000 Radio Servicemen now depend upon Radolek Service. Send for your copy of this big book. It will give you new ideas in conducting your service business on a more profitable basis.

Test Instruments—The most complete line ever displayed in any catalog. Latest improved models that provide every conceivable test necessary for thorough radio receiver analysis and repair. New push button tube testers that simplify and speed up testing time.

Over 12,000 Repair Parts, Tools, etc. Parts to repair any radio receiver made. All leading brands are represented. Every item guaranteed! And all at prices that SAVE YOU MONEY!

All Tubes Represented—RCA, Sylvania, Raytheon, Philco, etc. Includes Kellogg, special Majestic types and transmitting tubes.

Complete Public Address Display. New 1939 model public address amplifiers with outputs from 10 to 90 watts. Complete P. A. Systems for permanent, Mobile and Portable installations. Powerful beam power systems attractively designed and priced for greater profits.

Latest Radio Models. The super values of 1939. New Phono-Radio combinations. Automatic tuning sets with strikingly beautiful cabinets that harmonize with all home furnishings. Also new "Ham" receivers and TRANSMITTERS!

Complete Auto Radio Section. Includes vibrator replacement guide, new auto aerials at new low prices and custom panel control plates for all automobiles. And new Deleo Auto Sets that are the easiest to sell with the greatest profits.

Send for FREE catalog

The RADOLEK Co.

601 W. Randolph, Chicago, Dept. C-23

Send the Radolek Radio Profit Guide FREE.

Name

Address

Serviceman? Dealer? Experimenter?

Please Say That You Saw It in RADIO-CRAFT

**FOR UNEXCELLED PERFORMANCE
BUILD A BROWNING 83**

A four-band kit receiver having an exceptionally fine signal-to-noise ratio. Fool-proof phase inversion with push-pull audio gives remarkable tone quality. Band pass IF transformers provide freedom from adjacent channel interference without affecting audio fidelity. Listen in on epoch-making world events on a receiver that can really "bring them in."

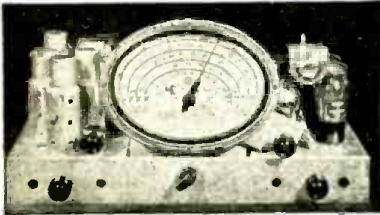

SPEND 6 HOURS

of your time to build a better receiver than you could buy for many times the cost. Full-sized, step-by-step pictorial wiring diagrams furnished with the kit make construction easy—even for the inexperienced.

The Browning 83 is designed for the experimenter—the man who wants the thrill of building the best in all around performance. The only tools required are a soldering iron, screw driver and a pair of pliers.

Write for illustrated Brochure.

AMATEURS

Have you seen the new BL-5 series of band-switching Tuners, designed exclusively for all-band excellers, preselectors, and receivers?

Write for BL-5 Bulletin.

BROWNING LABORATORIES Inc.

WINCHESTER, MASS.
EXPORT DEPT., 461 4TH AVE., N. Y. C.

TELETRAN

!!!

**MOST COMPLETE
LINE OF P.A.
and ACCESSORIES
ON THE MARKET
TODAY.**



Write for 20-page Catalog.

*

Licensed by ERPI under patents owned or controlled by A. T. & T. and Western Electric

TELETRAN PRODUCTS CO.

2233 University Ave.

St. Paul

Minnesota

BOOK REVIEW

RADIO TROUBLE-SHOOTER'S HANDBOOK. by Alfred A. Ghirardi. Published by Radio & Technical Publishing Co. Size 8 1/2 x 11 ins., over 500 pages. Price, \$3.00.

This book takes the place of Ghirardi's former "Radio Field Service Data Book," and is a companion volume to his comprehensive servicing text, "Modern Radio Servicing."

The 50 sections of "Handbook" cover every phase of radio repair service. It includes case histories of over 2,000 different set models; alignment frequencies and data on over 12,000 superhet-type receivers; service data on car-radio sets; service information on sound recorders, intercommunicating and P.A. systems; trade directories; over 30 charts and tables on grid-bias resistor values, design data, tube characteristics, etc.

Here's the newest book for the radio Serviceman.

PLEASE NOTE

The current issue of *Radio-Craft's* contemporary publication, *Radio and Television*, contains many articles of specific interest to several classes of *Radio-Craft* readers. Among the articles of exceptional interest in the current issue are the following:

How to Build a T.R.F. Television Receiver for 441 Lines—Henry Townsend, E.E.
A 110-Volt D.C. Transmitter—Herman Yellin, W2AJL.

5 to 50 Meter Superhet.—Harry D. Hooton, W8KPX.

Cathode-Ray "Monitor" for Ham Use—C. Walter Palmer, E.E.

Silver Trophy Contest—For Best Ham Station Photo.

Flat-Beam Antenna for Reception—John Kraus.

The Radio Beginner—Martin Clifford, W2CDV.

The current, November issue of *Radio and Television* is for sale on all newsstands October 10.

THE RADIO MONTH IN REVIEW

(Continued from page 263-264)

scheduled last month to make its debut in America on a full-fledged program hour, over John V. L. Hogan's high-fidelity station WQXR (1,550 kc.), at about *Radio-Craft's* press-date. Purpose of this transmission was to test the technique of the "tape transmission"—sound engraved by a sapphire on a 7-millimeter tape—as compared with recorded, transcribed and studio productions.

NEW 42-PASSENGER AIRLINER BOASTS SUPER-RADIO

(Continued from page 313)

Although the importance of this development to the immediate needs of the industry is obvious, its real significance is to be found in the future of aviation. "Over weather" or sub-stratospheric flight has been the dominant ambition of airline operators for more than a decade. Its realization necessitates flying above the clouds, and out of visual contact with the ground for long distances. Hence much of the involved problem of navigation must be shifted from the pilot's limited senses to the broader reach of radio.

Specifications for the new equipment were submitted by 4 leading airlines: United Air Lines Transport Corporation; Transcontinental and Western Air, Inc.; American Airlines, Inc.; Eastern Airlines, Inc.; and by the Douglas Aircraft Company, manufacturer of the DC-4. The system was designed by Bell Telephone Laboratories, Inc., and more than 2 years were required to perfect and complete the initial model.

Midgets in Size
GIANTS
in Quality...

TYPE BR



Type BR etched foil dry electrolytic "Blue Beavers", a new C-D development, completely eliminating exact duplicate replacements. Polarity clearly indicated on protective varnished sleeve fitted over pure aluminum cartridge. Hermetically sealed, vented and most practical for any service job. Eliminates drilling of chassis, nut nuts, washers, etc. The service engineer with an eye to profits will insist on dependable "Experience-tested" C-D "Blue Beavers".

TYPE DT



C-D famous "Dwarf-Tiger" paper tubulars need no superlatives to describe their fine qualities and electrical characteristics. Extensively used by leading set manufacturers C-D has produced millions of these tubulars—more than any other company. Non-inductively wound, specially sealed, with well-soldered rigidly anchored wire leads, these units are encased in impregnated cardboard tubes—insulating the capacitor from excessive moisture and temperatures.

TYPE 5W



Type 5W molded mica receiving capacitors are tested at 1000 volts D.C., and checked for accuracy of capacity by an electrical testing machine. These units are characteristic of the quality which C-D builds into its every product. The efficiency of these capacitors is better than 99.94%. Available in three types—1W, 3L, and 5W in a capacity range from .000005 to .01 mfd. Retain your professional standing with your customers by using C-D's exclusively.

FREE Catalog

New 40 page catalog illustrating the entire C-D capacitor line now available free of charge. Clip convenient coupon below for your copy



CORNELL-DUBILIER ELECTRIC CORPORATION
1014 HAMILTON BOULEVARD
SOUTH PLAINFIELD, N. J.

CORNELL-DUBILIER ELECTRIC CORPORATION
1014 HAMILTON BOULEVARD, SOUTH PLAINFIELD, N. J.

Rush to me copy of Catalog 161
Put my name on list for house organ

Name _____
Address _____
City _____ State _____

Please Say That You Saw It in RADIO-CRAFT

New RADIO HOME-STUDY IDEA

UP TO THE MINUTE AS A STREAMLINER..

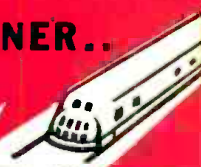

SPRAYBERRY

Personalized TRAINING

in RADIO

Get my FREE BOOK FOR AMAZING DETAILS

WITH THIS SENSATIONAL METHOD
YOU CAN LEARN RADIO—FASTER
MAKE BIGGER PROFITS—SOONER

I ACTUALLY SET YOU UP FOR YOUR OWN BUSINESS

Here's a brand-new, altogether different type of Radio Education that's specially designed to give you intense, practical, quick training for a money-making career in the fast-moving Radio Industry. A remarkable and important advantage of this new Personalized Sprayberry Training is that I backed you up all the way with close

personal attention. You may write me at any time for special help on any subject or work that is not perfectly clear and understandable to you . . . not only while you are learning—but after you have completed my Course and are actually working in Radio. Now let me show you how I equip you for your own business.

You Get REAL PROFESSIONAL

Equipment for Interesting Experimental Work

I SUPPLY YOU WITH THE FINEST EQUIPMENT OFFERED WITH ANY RADIO COURSE. With my Experimental Outfits you'll be able to carry out interesting, practical experiments that will make the theory of Radio crystal-clear to you. By actually working with real equipment . . . with your own hands you'll learn so you'll never forget. Then I supply you with fine Test Equipment to enable you to get into the money-making side of Radio by doing actual Radio Service Work shortly after you begin your training.

I SHOW YOU HOW TO MAKE GOOD SPARE-TIME MONEY WHILE YOU'RE LEARNING

Right at the beginning of your Training, I supply you with a valuable set of spare-time Business Builders which will show you how and where to get profitable Radio service jobs right in your own neighborhood. You'll be able to make practical application of the theories learned and practical use of the equipment given. Moreover, you'll get invaluable practical experience . . . and add to your bank account at the same time.

YOU RECEIVE PERSONAL COACHING SERVICE ALL THE WAY

DON'T DELAY!

SPRAYBERRY ACADEMY **Act Now**
OF RADIO
F. L. Sprayberry, Pres.
120-L University Place, N. W.
Washington, D. C.

Please send me FREE copy of "HOW TO MAKE MONEY IN RADIO."

NAME AGE

ADDRESS

CITY STATE

Tear off this coupon, mail in envelope or paste on penny postcard

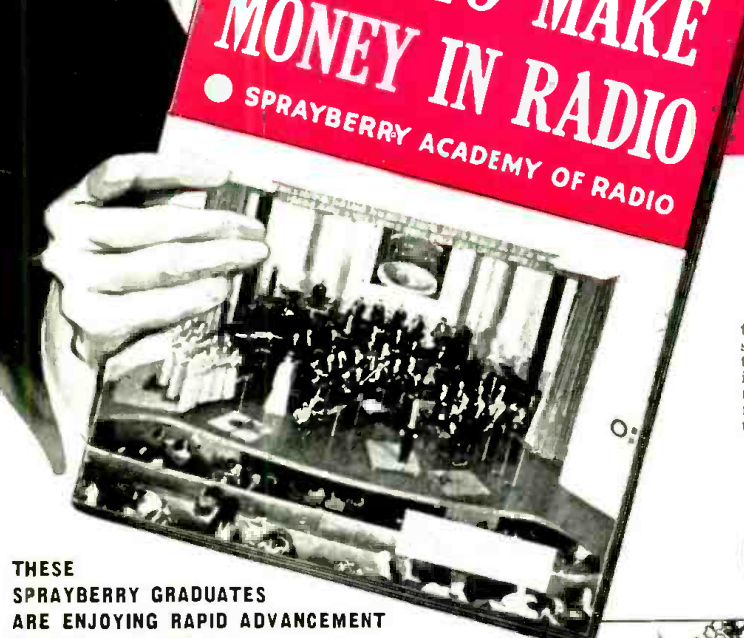

THESE
SPRAYBERRY GRADUATES
ARE ENJOYING RAPID ADVANCEMENT
WITH BIG FUTURE AHEAD

Deluged with Work

Edwin A. Gammon, Auburn, Me., writes: "Your Course is so thoroughly good and practical that it is hard to pick out one part that is better than any other. Due to the knowledge I have gotten from it, I have been deluged with work for the last month, achieving good results with Radios which had been unsatisfactorily tackled by other servicemen. You deserve all the credit."

"Cleared" \$150 in Spare Time

A. H. Lanoie, Northridge, Mass., writes: "Since enrolling in your course, I have cleared a net profit of more than \$150 in spare time alone . . . and I am not one-half through the course yet. Honestly, I cannot understand how you can give so much 'dope' for so little money."

NO PREVIOUS EXPERIENCE NEEDED

My training starts right at the beginning of Radio . . . unfolds each subject in a simplified, logical, understandable style. You easily learn all about Television, Electronics, Police Radio, Ship Radio, Commercial Radio Broadcasting . . . Radio Set Repair and Installation Work, etc. Every essential subject of Radio is covered.

QUIT DREAMING! MAKE A FUTURE FOR YOURSELF

Prepare for a Good Paying Job

No matter if you desire to BE YOUR OWN BOSS in your own business . . . or hold down a good job in Radio, my Training will give you the quickest and best preparation available anywhere. It is easy enough to sit idly by and envy those fellows who have good-paying jobs and are building toward splendid incomes and real security in the future. BUT THESE FELLOWS ARE NO SMARTER THAN YOU. The essential difference is that they have taken the initiative to pull themselves up by their own bootstraps. You can do the same thing. Don't just "wish" for more money . . . start training for it—RIGHT NOW.

REMEMBER—THE SPRAYBERRY COURSE IS SOLD UNDER AN IRON-CLAD, MONEY-BACK AGREEMENT

RUSH THIS COUPON for Big FREE Book

SERVICEMEN!

I offer special Advanced Training for those already in Radio. I'll show you the newest methods . . . newest circuits and short-cuts. I'll show you how to do the jobs other Radio men can't handle . . . how to really cash in on your ability. Complete details of this Advanced Course and Fundamental Course, Features, etc., fully described in my new 41-page FREE BOOK.

QUICK ADVANCEMENT in RADIO

Exactly what you need for

IT'S FUN TO BUILD A

MEISSNER KIT!

7-TUBE AC 2-BAND "UTILITY" SUPER

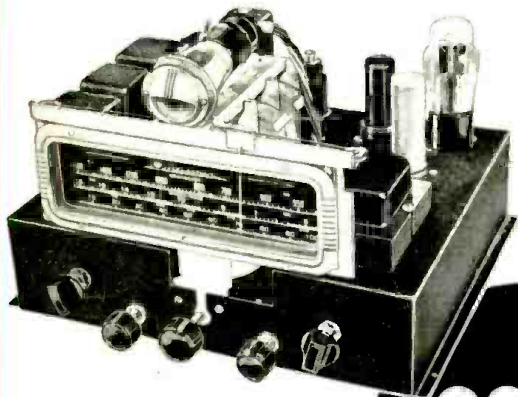

\$23²⁵

This Meissner Kit is an exceptional value. A full-size radio receiver with all the latest features—yet anyone can build it in just a few evenings. Only a screw-driver, pliers and a soldering iron are necessary.

This model includes 7 tubes, 2 bands, 3-gang condenser, Ferrocart (iron-core) I.F. channel, diode second detector, sensitivity control, automatic volume control, audio volume control, full vision calibrated dial—and gives 4.25 watts undistorted output!

Ask your Parts Jobber for Meissner Kit No. 10-1104.

5-TUBE AC T.R.F. KIT



\$12⁹⁰

An exceptional radio receiver that anyone can build in two evenings' time! Uses a modernized T. R. F. circuit to give "big set" tone quality and yet retain sensitivity and selectivity far superior to the ordinary 5-tube receiver.

It has a large illuminated airplane dial, tone control, 3-gang condenser, pentode output and all the latest features. Comes complete, ready for "Breadboard" assembly, less only tubes and speaker. Or already-punched, heavy-gauge chassis base can be included for a slight extra cost. And it is fully guaranteed to operate to your complete satisfaction!

Just ask your Parts Jobber for Meissner Kit No. 10-1106. If he does not have it in stock, just write the factory. We will tell you where you can get it.

MAIL THIS COUPON!

MEISSNER MANUFACTURING CO.
Mt. Carmel, Illinois. Dept. RC-11
Please send me full details on
Meissner Kits.

NAME

STREET

CITY

STATE



MT. CARMEL, ILL.

Meissner

"A FAMOUS NAME FOR TWO DECADES"